



KRAMER ELECTRONICS LTD.

USER MANUAL

MODEL:

VS-66HDCPxI
6x6 DVI Matrix Switcher

P/N: 2900-300018 Rev 9



VS-66HDCPxI Quick Start Guide

This guide helps you install and use your product for the first time. For more detailed information, go to <http://bit.ly/k-prod-downloads> to download the latest manual or scan the QR code on the left.

Step 1: Check what's in the box

- VS-66HDCPxI 6x6 DVI Matrix Switcher
- 1 Quick Start Guide
- 1 Power cord
- 1 Set of rack "ears"
- 4 Rubber feet
- Kramer RC-IR3 Infrared Remote Control Transmitter with batteries and user manual

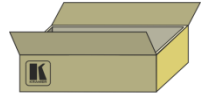

Step 2: Install the VS-66HDCPxI

Mount the machine in a rack (using the included rack "ears") or attach the rubber feet and place on a table.

Step 3: Connect the inputs and outputs

Always switch off the power on each device before connecting it to your VS-66HDCPxI.

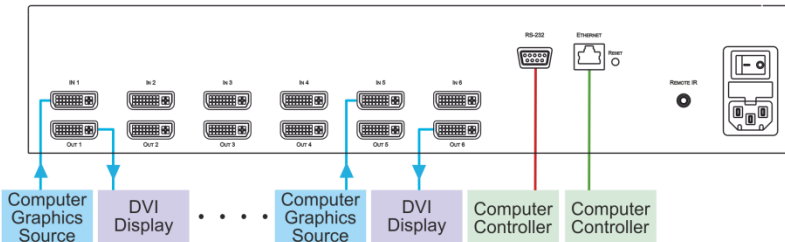

Always use Kramer high-performance cables for connecting AV equipment to the VS-66HDCPxI.

Step 4: Connect the power

Connect the power cord to the VS-66HDCPxI and plug it into the mains



Step 5: Operate the VS-66HDCPxI

Acquire the EDID from a connected output

1. Press and hold the EDID and STO buttons for 3 seconds. Both buttons flash.
2. Press the INPUT button that receives the EDID. The input number flashes on display.
3. Press the OUTPUT button where the display is connected.
4. Press the EDID button.
5. When the buttons stop flashing and the display returns to normal, the EDID is acquired.

Store a preset

1. Set the device to the desired I/O setting.
2. Press the STO button. The STO button flashes.
3. Select an IN or OUT button to store the device setting.
4. Press the STO button to store the current setup.

Switch an input to an output

Press an output button followed by an input button to switch the pair

Recall a preset

1. Press the RCL button. The RCL button flashes.
2. Press the relevant IN or OUT button.
3. Press the RCL button to recall the stored setting.

Contents

1	Introduction	1
2	Getting Started	2
2.1	Achieving the Best Performance	2
2.2	Safety Instructions	3
2.3	Recycling Kramer Products	3
3	Overview	4
3.1	About Fast Switching	5
3.2	Defining the VS-66HDCPxI 6x6 DVI Matrix Switcher	5
3.3	Using the IR Transmitter	8
4	Installing in a Rack	9
5	Connecting the VS-66HDCPxI	10
5.1	Connecting to the VS-66HDCPxI via RS-232	11
5.2	Connecting via Ethernet	12
6	Operating the VS-66HDCPxI 6x6 DVI Matrix Switcher	13
6.1	Routing Inputs to Outputs	13
6.2	Disconnecting the Outputs	13
6.3	Storing and Recalling a Setup	14
6.4	Changing the Port Switching Speed	15
6.5	Acquiring the EDID	16
6.6	Locking and Unlocking the Front Panel	18
6.7	Resetting the Ethernet Configuration to Default Values	18
6.8	Controlling Configuration via the Ethernet Port	18
6.9	Firmware Upgrade	18
7	Technical Specifications	19
8	Default Communication Parameters	20
9	Kramer Protocol 2000	21
10	Application Software Tools	24
10.1	Control Methods	24
10.2	Firmware Upgrade	24

Figures

Figure 1: VS-66HDCPxI 6x6 DVI Matrix Switcher Front Panel	6
Figure 2: VS-66HDCPxI 6x6 DVI Matrix Switcher Rear Panel	7
Figure 3: Connecting the VS-66HDCPxI 6x6 DVI Matrix Switcher	11
Figure 4: SELECTOR Buttons	14

1 Introduction

Welcome to Kramer Electronics! Since 1981, Kramer Electronics has been providing a world of unique, creative, and affordable solutions to the vast range of problems that confront the video, audio, presentation, and broadcasting professional on a daily basis. In recent years, we have redesigned and upgraded most of our line, making the best even better!

Our 1,000-plus different models now appear in 14 groups that are clearly defined by function: GROUP 1: Distribution Amplifiers; GROUP 2: Switchers and Routers; GROUP 3: Control Systems; GROUP 4: Format/Standards Converters; GROUP 5: Range Extenders and Repeaters; GROUP 6: Specialty AV Products; GROUP 7: Scan Converters and Scalers; GROUP 8: Cables and Connectors; GROUP 9: Room Connectivity; GROUP 10: Accessories and Rack Adapters; GROUP 11: Sierra Video Products; GROUP 12: Digital Signage; GROUP 13: Audio; and GROUP 14: Collaboration.

Congratulations on purchasing your Kramer **VS-66HDCPxI** 6x6 DVI Matrix Switcher, which is ideal for the following typical applications:

- Conference room presentations
- Advertising
- Rental and staging

2 Getting Started

We recommend that you:

- Unpack the equipment carefully and save the original box and packaging materials for possible future shipment
- Review the contents of this user manual



Go to <http://www.kramerav.com/downloads/VS-66HDCPxI> to check for up-to-date user manuals, application programs, and to check if firmware upgrades are available (where appropriate).

2.1 Achieving the Best Performance

To achieve the best performance:

- Use only good quality connection cables (we recommend Kramer high-performance, high-resolution cables) to avoid interference, deterioration in signal quality due to poor matching, and elevated noise levels (often associated with low quality cables)
- Do not secure the cables in tight bundles or roll the slack into tight coils
- Avoid interference from neighboring electrical appliances that may adversely influence signal quality
- Position your Kramer **VS-66HDCPxI** away from moisture, excessive sunlight and dust



This equipment is to be used only inside a building. It may only be connected to other equipment that is installed inside a building.

2.2 Safety Instructions



Caution: There are no operator serviceable parts inside the unit

Warning: Use only the power cord that is supplied with the unit

Warning: Do not open the unit. High voltages can cause electrical shock! Servicing by qualified personnel only

Warning: Disconnect the power and unplug the unit from the wall before installing

2.3 Recycling Kramer Products

The Waste Electrical and Electronic Equipment (WEEE) Directive 2002/96/EC aims to reduce the amount of WEEE sent for disposal to landfill or incineration by requiring it to be collected and recycled. To comply with the WEEE Directive, Kramer Electronics has made arrangements with the European Advanced Recycling Network (EARN) and will cover any costs of treatment, recycling and recovery of waste Kramer Electronics branded equipment on arrival at the EARN facility. For details of Kramer's recycling arrangements in your particular country go to our recycling pages at <http://www.kramerelectronics.com/support/recycling/>.

3 Overview

The high quality Kramer **VS-66HDCPxI** is an HDCP compatible 6 x 6 DVI Matrix Switcher that accepts up to six DVI inputs and routes the selected DVI input signal to any or all of six DVI outputs.

Note that only the digital signal (DVI D) is available on the DVI connector.

- The **VS-66HDCPxI** features:
- Max. Data Rate - 6.75Gbps (2.25Gbps per graphic channel)
- HDTV Compatibility
- HDCP Compliance
- HDMI Support for Deep Color, x.v.Color™, 3D Pass-Through, HDMI Compressed Audio Channels
- Input/Output - DVI-D signals (on DVI-I connectors)
- Kramer Equalization and re-Klocking™ Technology - Rebuilds the digital signal integrity to travel longer distances
- EDID Capture - Copies and stores the EDID from a display device
- Fast Switching Technology - Reduces switching delay between DVI/HDMI sources
- Output Disconnect - Each output
- Front Panel Lockout
- Memory Locations - Stores multiple switches as presets to be recalled and executed when needed
- Worldwide Power Supply - 100-240V AC
- Standard 19-inch Rack Mount Size - 2U. Rack “ears” included

You can control the **VS-66HDCPxI** using the front panel buttons or remotely via:

- RS-232 serial commands transmitted by a touch screen system, PC or other serial controller
- The Kramer infrared remote control transmitter
- The Ethernet port
- An external remote IR receiver (optional), see [Section 3.3](#)

3.1 About Fast Switching

Older display devices required a longer time between the loss of one digital signal and the introduction of another, as well as a physical disconnection of the interconnecting cable in order to be able to detect and adjust to the new video attributes and parameters. Normal switching, therefore, introduced a 5V signal disconnection along with a delay in switching. Many newer display devices, however, are now capable of “on-the-fly” switching.

Depending on the display device in use, the **VS-66HDCPxI** allows for fast switching (minor reset and the connection kept alive) and extra fast switching (no reset and the connection kept alive). Using the fast and extra fast switching modes allows for fraction-of-a-second switching times when using high performance display devices or when using a scaler on the video output.

3.2 Defining the VS-66HDCPxI 6x6 DVI Matrix Switcher

This section defines the **VS-66HDCPxI**.

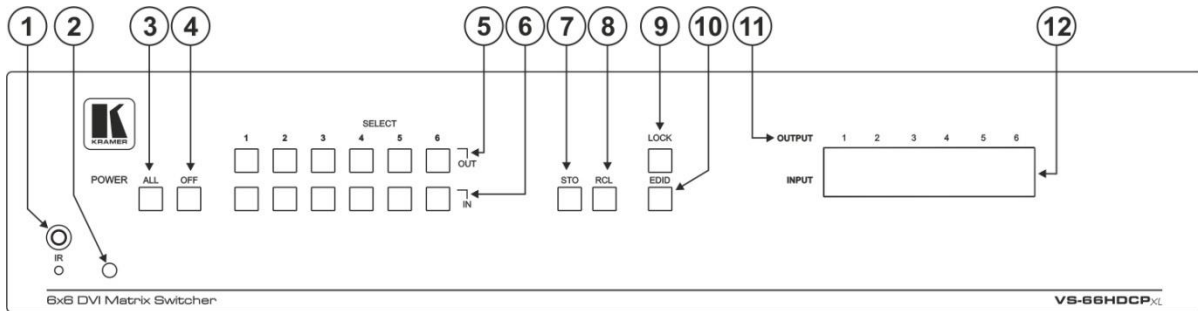



Figure 1: VS-66HDCPxL 6x6 DVI Matrix Switcher Front Panel

#	Feature	Function
1	IR Receiver and LED	IR remote control sensor. LED lights yellow when receiving an IR signal
2	POWER LED	Lights green when the unit is turned on
3	ALL Button	Press to select all inputs or all outputs (see Section 6.1)
4	OFF Button	Press to disconnect one or all outputs (see Section 6.2)
5	SELECT OUT Buttons	Press to select an output (from 1 to 6) Note that when a sink is connected to an output, that output button lights  If a screen that does not support HDCP is connected to an output, the button of that output may possibly remain unlit
6	SELECT IN Buttons	Press to select an input (from 1 to 6) Note that when there is a live signal at an input, that input button lights
7	STO Button	Press to store a switching configuration
8	RCL Button	Press to recall a switching configuration
9	LOCK Button	Press and hold to lock the front panel buttons and to acquire the EDID (see Section 6.6). Press and hold a second time to unlock the front panel buttons
10	EDID Button	Press to acquire the EDID
11	OUTPUT 1 to 6	Indicates the output channels and their respective input selections on the 7-segment display
12	INPUT 7-segment Display	Number shown on the display indicates the relevant input channel

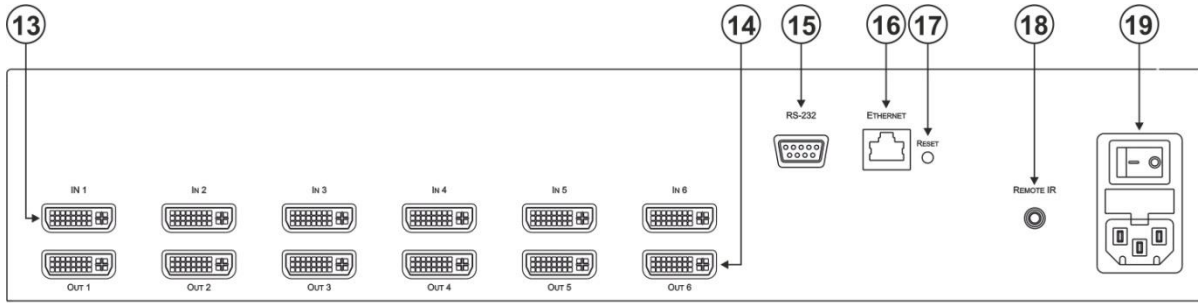

Figure 2: VS-66HDCPxI 6x6 DVI Matrix Switcher Rear Panel

#	Feature	Function
13	<i>INPUT</i> DVI Connectors	Connect to the DVI sources (from 1 to 6)
14	<i>OUTPUT</i> DVI Connectors	Connect to the DVI acceptors (from 1 to 6)
15	RS-232 9-pin D-sub (F) Connector	Connects to a PC or the serial remote controller (see Section 8)
16	ETHERNET RJ-45 Connector	Connects to a PC or other Ethernet controller via a LAN (see Section 8)
17	RESET Button	Press and hold to reset the Ethernet configuration to its factory default values (see Section 8)
18	REMOTE IR 3.5mm Mini Jack	Connects to an external IR receiver unit for controlling the machine via an IR remote controller (instead of using the front panel IR receiver), see Section 3.3
19	Mains Power Connector with Switch and Fuse	Connects to the AC mains supply and switches the unit on or off

3.3 Using the IR Transmitter

You can use the **RC-IR3** IR transmitter to control the machine via the built-in IR receiver on the front panel or, instead, via an optional external IR receiver (Model: C-A35M/IRR-50). The external IR receiver can be located up to 15 meters away from the machine. This distance can be extended to up to 60 meters when used with three extension cables (Model: C-A35M/A35F-50).

Before using the external IR receiver, be sure to arrange for your Kramer dealer to insert the internal IR connection cable (P/N: 505-70434010-S) with the 3.5mm connector that fits into the REMOTE IR opening on the rear panel. Connect the external IR receiver to the REMOTE IR 3.5mm connector.

4 Installing in a Rack

This section provides instructions for rack mounting the unit.

Before installing in a rack, be sure that the environment is within the recommended range:

OPERATING TEMPERATURE:	0° to +40°C (32° to 104°F)
STORAGE TEMPERATURE:	-40° to +70°C (-40° to 158°F)
HUMIDITY:	10% to 90%, RHL non-condensing



CAUTION!

When installing on a 19" rack, avoid hazards by taking care that:

1. It is located within the recommended environmental conditions, as the operating ambient temperature of a closed or multi unit rack assembly may exceed the room ambient temperature.
2. Once rack mounted, enough air will still flow around the machine.
3. The machine is placed straight in the correct horizontal position.
4. You do not overload the circuit(s). When connecting the machine to the supply circuit, overloading the circuits might have a detrimental effect on overcurrent protection and supply wiring. Refer to the appropriate nameplate ratings for information. For example, for fuse replacement, see the value printed on the product label.
5. The machine is earthed (grounded) in a reliable way and is connected only to an electricity socket with grounding. Pay particular attention to situations where electricity is supplied indirectly (when the power cord is not plugged directly into the socket in the wall), for example, when using an extension cable or a power strip, and that you use only the power cord that is supplied with the machine.

To rack-mount a machine:

1. Attach both ear brackets to the machine. To do so, remove the screws from each side of the machine (3 on each side), and replace those screws through the ear brackets.

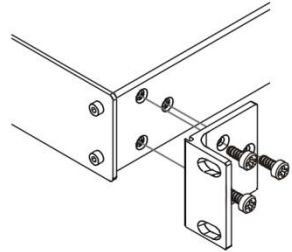

2. Place the ears of the machine against the rack rails, and insert the proper screws (not provided) through each of the four holes in the rack ears.

Note:

- In some models, the front panel may feature built-in rack ears
- Detachable rack ears can be removed for desktop use
- Always mount the machine in the rack before you attach any cables or connect the machine to the power
- If you are using a Kramer rack adapter kit (for a machine that is not 19"), see the Rack Adapters user manual for installation instructions available from our Web site

5 Connecting the VS-66HDCPxI



Always switch off the power to each device before connecting it to your **VS-66HDCPxI**. After connecting your **VS-66HDCPxI**, connect its power and then switch on the power to each device.

To connect the **VS-66HDCPxI** as illustrated in the example in [Figure 3](#):

1. Connect up to six DVI sources (for example, computer graphics sources) to the IN DVI connectors.
2. Connect the OUT DVI connectors to up to six DVI acceptors (for example, DVI displays).
3. If required, connect a PC and/or controller to the RS-232 port (see [Section 5.1](#)) and/or the Ethernet port (see [Section 5.1](#)).
4. Connect the device to the mains electricity (not shown in [Figure 3](#)).
5. Power the device.
6. If required, acquire the EDID (see [Section 6.5](#)).

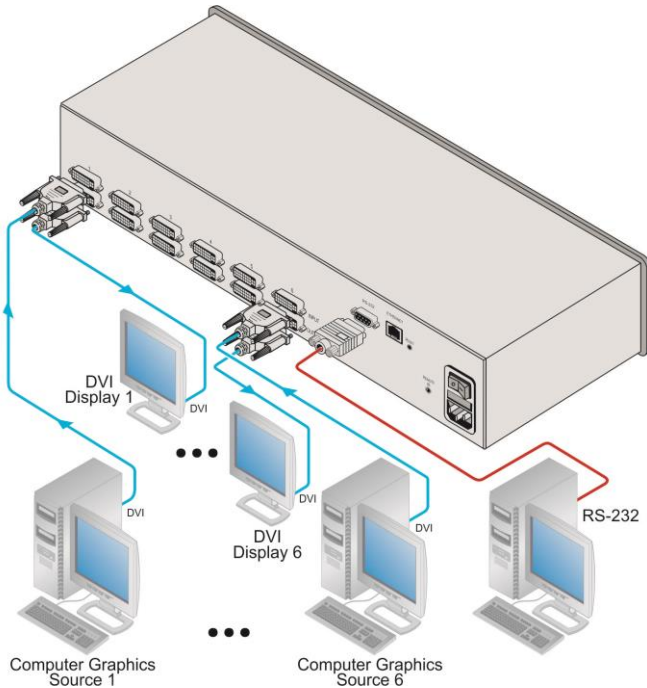

Figure 3: Connecting the VS-66HDCPxI 6x6 DVI Matrix Switcher

5.1 Connecting to the VS-66HDCPxI via RS-232

You can connect to the **VS-66HDCPxI** via an RS-232 connection using, for example, a PC. Note that a null-modem adapter/connection is not required.

To connect to the **VS-66HDCPxI** via RS-232:

- Connect the RS-232 9-pin D-sub rear panel port on the **VS-66HDCPxI** unit via a 9-wire straight cable (only pin 2 to pin 2, pin 3 to pin 3, and pin 5 to pin 5 need to be connected) to the RS-232 9-pin D-sub port on your PC

5.2 Connecting via Ethernet

You can connect to the **VS-66HDCPxI** via Ethernet using either of the following methods:

- Directly to the PC using a crossover cable (see [Section 5.2.1](#))
- Via a network hub, switch, or router, using a straight-through cable (see [Section 5.2.2](#))

After connecting the **VS-66HDCPxI** to the Ethernet port, configure your local Ethernet port by following the instructions in the Ethernet Configuration (K-LanConfigurator) guide available from http://www.kramerelectronics.com/support/product_downloads.asp or from the Downloads section of the **VS-66HDCPxI** Web page.

Note: If you want to connect via a router and your IT system is based on IPv6, speak to your IT department for specific installation instructions.

5.2.1 Connecting the Ethernet Port Directly to a PC

You can connect the Ethernet port of the **VS-66HDCPxI** directly to the Ethernet port on your PC using a crossover cable with RJ-45 connectors.



This type of connection is recommended for identifying the **VS-66HDCPxI** with the factory configured default IP address.

5.2.2 Connecting the Ethernet Port via a Network Hub or Switch

You can connect the Ethernet port of the **VS-66HDCPxI** to the Ethernet port on a network hub or using a straight-through cable with RJ-45 connectors.

6 Operating the VS-66HDCPxI 6x6 DVI Matrix Switcher

This section describes how to:

- Route inputs to outputs (see [Section 6.1](#))
- Disconnect outputs (see [Section 6.2](#))
- Store and recall a setup (see [Section 6.3](#))
- Change the port switching speed (see [Section 6.4](#))
- Acquire the EDID (see [Section 6.5](#))
- Lock and unlock the front panel (see [Section 6.6](#))
- Reset the Ethernet configuration to default values (see [Section 6.7](#))
- Control the machine via the Ethernet port (see [Section 6.8](#))

6.1 Routing Inputs to Outputs

To route an input to an output:

- Press an OUT key, followed by an IN key to route this input to that output

To route one input to all outputs:

- Press ALL followed by an IN button. The input is routed to all outputs

6.2 Disconnecting the Outputs

To disconnect one output:

- Press the OUT button of the output to disconnect and press OFF

To disconnect all outputs at once:

- Press the ALL button and then press OFF. This disconnects all the outputs

6.3 Storing and Recalling a Setup

You can use the STO and RCL buttons to store up to 12 setups and then recall them as illustrated in [Figure 4](#).

IN 1 is used for setup number 1 and OUT 1 is used for setup number 7.

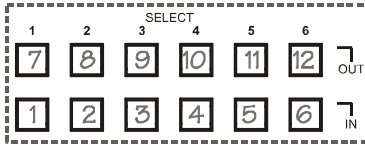

Figure 4: SELECTOR Buttons



The gray numbers (1 to 12) in [Figure 4](#) that illustrate the corresponding store/recall configuration numbers are for the purpose of illustration only and do not actually appear on the buttons.

To store a setup (for example, to preset 10):

1. Configure the switching as required for the preset
2. Press the STO button.
The STO button flashes.
3. Select an OUT or IN SELECT button to store the machine setup (for example, OUT 4 for preset 10).
4. Press the STO button to store the current setup.
In this example, the OUT 4 button stores the setup.
Press the STO button within 10 seconds as the store operation times out automatically after this period.

To recall a setup (for example, from preset 10):

1. Press the RCL button.
The RCL button flashes.
2. Press the relevant OUT or IN button that stored the setup.
In this example, press OUT 4 for preset 10.
3. Press the RCL button to recall the stored setup.

6.4 Changing the Port Switching Speed

The switching speed can be set per port to any of the following:

- 3—Normal (default)
- 2—Fast
- 1—Extra fast

To change the port switching speed:

1. Ensure that the device is in normal switching mode, (that is, not Store, Recall or EDID mode).
2. Press the RCL and EDID buttons at the same time.
The RCL and EDID buttons flash, and the display indicates the switching speed mode of each port.
IN 1, IN 2 and IN 3 are illuminated (red).
3. Press one or more (or ALL) of the OUT buttons to select the port to change.
The selected port setting on the LED display flashes.
4. Press one of the IN 1/IN 2/IN 3 button to toggle the switching speed, (to Extra fast/Fast/Normal, respectively).
The switching speed displayed changes for the selected ports.
5. Press the LOCK button to confirm the change.
The switching speed for the selected port is changed and the device reverts to the normal switching mode.

Note: If the LOCK button is not pressed within about 12 seconds, the device exits the port speed switching mode automatically and all changes are lost.

6.5 Acquiring the EDID

You can acquire the EDID from:

- One output set to one or more of the six inputs (see [Section 6.5.1](#))
- Different outputs set to different inputs (see [Section 6.5.2](#))
- The default EDID (see [Section 6.5.3](#))

6.5.1 Acquiring an EDID from a Single Connected Output

To acquire or change the EDID of a new output display:

1. Connect the required acceptor to the output from which you want to acquire the EDID.
2. Press the EDID and STO buttons simultaneously and hold them for 3 seconds.
Both buttons flash.
3. Press the IN SELECT button to which the EDID is to be copied.
The selected input number flashes on the display.
4. Select the OUT SELECT button from which the EDID is to be acquired.
5. Press the EDID button.
The EDID has been captured when the display returns to normal.

6.5.2 Acquiring an EDID from Several Sets of Inputs and Outputs

To acquire the EDID from several sets of inputs and outputs (for example, OUT 1 to IN 1 and OUT 6 to IN 3):

1. Connect the required acceptors to the outputs from which you want to acquire the EDID.
2. Press the EDID and STO buttons simultaneously and hold them for 3 seconds.
Both buttons flash.

3. Press the SELECT IN button to which the first EDID is to be copied (for example, IN 1).
The selected input number flashes on the display.
4. Press the SELECT OUT button from which the first EDID is to be acquired (for example, OUT 1).
5. Press the SELECT IN 1 button again.
The IN 1 button stops flashing.
6. Press another SELECT IN to which the next EDID is to be copied (for example, IN 3).
The selected input number flashes on the display.
7. Press the SELECT OUT button from which the next EDID is to be acquired (for example, OUT 6).
8. Press the SELECT IN 3 button again.
The IN 3 button stops flashing.
9. Press the SELECT IN buttons to which you want to copy the EDID (for example, IN 1 and IN 3).
10. Insure that the relevant input numbers flash on the display.
11. Press the EDID button.
The process is complete when the display returns to normal.

6.5.3 Acquiring the Default EDID

To reset to the default EDID:

1. Press the EDID and STO buttons simultaneously and hold them for 3 seconds.
Both buttons flash.
2. Press the SELECT IN button that copies the EDID.
The selected input number flashes on the display.
3. Press the OFF button until a "0" (zero) appears on the display.

4. Press the EDID button.

The process is complete when the display returns to normal.

6.6 Locking and Unlocking the Front Panel

To prevent unintended tampering with the unit via the front panel buttons, lock your **VS-66HDCPxI**.

To lock the **VS-66HDCPxI**:

- Press the PANEL LOCK button on the front

6.7 Resetting the Ethernet Configuration to Default Values



This procedure resets only the IP related parameters. All switching and preset values remain unchanged.

To reset the IP parameters to their default values (see [Section 8](#)):

- Press and hold the ETH Reset button on the rear panel while powering up the device

6.8 Controlling Configuration via the Ethernet Port

To control several units via Ethernet, connect the Master unit (Machine # 1) Ethernet port on your PC. Use your PC to configure the initial settings (see [Section 5.1](#)).

6.9 Firmware Upgrade

Instructions for upgrading the firmware can be found in the *STC Firmware Upgrade* document.

7 Technical Specifications

INPUTS:	6 DVI connectors
OUTPUTS:	6 DVI connectors
MAX. DATA RATE:	6.75Gbps (2.25Gbps per graphic channel)
COMPLIANCE WITH STANDARDS:	Supports DVI and HDCP
MAX RESOLUTION:	Up to UXGA; 1080p
POWER CONSUMPTION:	100–240VAC; 50/60Hz, 38VA
CONTROLS:	Front panel buttons, infrared remote control transmitter, RS-232, Ethernet
OPERATING TEMPERATURE:	0° to +40°C (32° to 104°F)
STORAGE TEMPERATURE:	-40° to +70°C (-40° to 158°F)
HUMIDITY:	10% to 90%, RHL non-condensing
PRODUCT DIMENSIONS:	19" x 9.29" x 2U (43.6cm x 23.60cm 8.80cm) W, D, H
SHIPPING DIMENSIONS:	21.65" x 13.39" x 6.10" (55.00cm x 34.00cm x 15.50cm) W, D, H
WEIGHT:	2.5kg (5.5lbs) approx.
INCLUDED ACCESSORIES:	Power cord, IR transmitter, rack "ears"
OPTIONS:	External remote IR receiver cable
Specifications are subject to change without notice at http://www.kramerelectronics.com	

8 Default Communication Parameters

RS-232 Protocol 2000	
Baud Rate:	9600
Data Bits:	8
Stop Bits:	1
Parity:	None
Command Format:	HEX
Example (Output 1 to Input 1):	0x01, 0x81, 0x81, 0x81
Ethernet	
IP Address:	192.168.1.39
TCP Port:	5000
UDP Port:	50000
Subnet Mask:	255.255.255.0

9 Kramer Protocol 2000

The Kramer Protocol 2000 RS-232/RS-485 communication uses four bytes of information as defined below.

MSB								LSB
		DESTINATION	INSTRUCTION					
0	D	N5	N4	N3	N2	N1	N0	
7	6	5	4	3	2	1	0	
1st byte								
		INPUT						
1	I6	I5	I4	I3	I2	I1	I0	
7	6	5	4	3	2	1	0	
2nd byte								
		OUTPUT						
1	O6	O5	O4	O3	O2	O1	O0	
7	6	5	4	3	2	1	0	
3rd byte								
		MACHINE NUMBER						
1	OVR	X	M4	M3	M2	M1	M0	
7	6	5	4	3	2	1	0	
4th byte								

1st BYTE: Bit 7 – Defined as 0.

D – "DESTINATION": 0 - for sending information to the switchers (from the PC);

1 - for sending to the PC (from the switcher).

N5...N0 – "INSTRUCTION"

The function that is to be performed by the switcher(s) is defined by the INSTRUCTION (6 bits). Similarly, if a function is performed via the machine's keyboard, then these bits are set with the INSTRUCTION NO., which was performed. The instruction codes are defined according to the table below (INSTRUCTION NO. is the value to be set for N5...N0).

2nd BYTE: Bit 7 – Defined as 1.

I6...I0 – "INPUT".

When switching (ie. instruction codes 1 and 2), the INPUT (7 bits) is set as the input number which is to be switched.

Similarly, if switching is done via the machine's front-panel, then these bits are set with the INPUT NUMBER which was switched. For other operations, these bits are defined according to the table.

3rd BYTE: Bit 7 – Defined as 1.

O6...O0 – "OUTPUT".

When switching (ie. instruction codes 1 and 2), the OUTPUT (7 bits) is set as the output number which is to be switched.

Similarly, if switching is done via the machine's front-panel, then these bits are set with the OUTPUT NUMBER which was switched. For other operations, these bits are defined according to the table.

4th BYTE: Bit 7 – Defined as 1.

Bit 5 – Don't care.

OVR – Machine number override.

M4...M0 – MACHINE NUMBER.

Used to address machines in a system via their machine numbers. When several machines are controlled from a single serial port, they are usually configured together with each machine having an individual machine number. If the OVR bit is set, then all machine numbers accept (implement) the command, and the addressed machine replies. For a single machine controlled via the serial port, always set M4...M0 = 1, and make sure that the machine itself is configured as MACHINE NUMBER = 1.

All the values in the table are decimal, unless otherwise stated



Instruction Codes for Protocol 2000				
Instruction		Definition for Specific Instruction		Notes
#	Description	Input	Output	
0	RESET VIDEO	0	0	1
1	SWITCH VIDEO	Set equal to video input which is to be switched (0 = disconnect)	Set equal to video output which is to be switched (0 = to all the outputs)	2, 15
3	STORE VIDEO STATUS	Set as SETUP #	0 - to store 1 - to delete	2, 3, 15
4	RECALL VIDEO STATUS	Set as SETUP #	0	2, 3, 15
5	REQUEST STATUS OF A VIDEO OUTPUT	Set as SETUP #	Equal to output number whose status is required	4, 3
15	REQUEST WHETHER SETUP IS DEFINED / VALID INPUT IS DETECTED	SETUP # or Input #	0 - for checking if setup is defined 1 - for checking if input is valid	8
30	LOCK FRONT PANEL	0 - Panel unlocked 1 - Panel locked	0	2
31	REQUEST WHETHER PANEL IS LOCKED	0	0	16
61	IDENTIFY MACHINE	1 - video machine name 2 - audio machine name 3 - video software version 4 - audio software version 5 - RS422 controller name 6 - RS422 controller version 7 - remote control name 8 - remote software version 9 - Protocol 2000 revision	0 - Request first 4 digits 1 - Request first suffix 2 - Request second suffix 3 - Request third suffix 10 - Request first prefix 11 - Request second prefix 12 - Request third prefix	13
62	DEFINE MACHINE	1 - number of inputs 2 - number of outputs 3 - number of setups	1 - for video 2 - for audio 3 - for SDI 4 - for remote panel 5 - for RS-422 controller	14

NOTES on the above table:

NOTE 1 - When the master switcher is reset, (e.g. when it is turned on), the reset code is sent to the PC. If this code is sent to the switchers, it resets according to the present power-down settings.

NOTE 2 - These are bi-directional definitions. That is, if the switcher receives the code, it performs the instruction; and if the instruction is performed (due to a keystroke operation on the front panel), then these codes are sent. For example, if the HEX code

01 85 88 83

was sent from the PC, then the switcher (machine 3) switches input 5 to output 8. If the user switched input 1 to output 7 via the front panel keypad, then the switcher sends HEX codes:

41 81 87 83

to the PC.

When the PC sends one of the commands in this group to the switcher, then, if the instruction is valid, the switcher replies by sending to the PC the same four bytes that it was sent (except for the first byte, where the DESTINATION bit is set high).

NOTE 3 - SETUP # 0 is the present setting. SETUP # 1 and higher are the settings saved in the switcher's memory, (i.e. those used for Store and Recall).

NOTE 4 - The reply to a "REQUEST" instruction is as follows: the same instruction and INPUT codes as were sent are returned, and the OUTPUT is assigned the value of the requested parameter. The replies to instructions 10 and 11 are as per the definitions in instructions 7 and 8 respectively. For example, if the present status of machine number 5 is

breakaway setting, then the reply to the HEX code

0B 80 80 85

would be HEX codes

4B 80 81 85

NOTE 8 - The reply is as in TYPE 3 above, except that here the OUTPUT is assigned with the value 0 if the setup is not defined / no valid input is detected; or 1 if it is defined / valid input is detected.

NOTE 13 - This is a request to identify the switcher/s in the system. If the OUTPUT is set as 0, and the INPUT is set as 1, 2, 5 or 7, the machine sends its name. The reply is the decimal value of the INPUT and OUTPUT. For example, for a 2216, the reply to the request to send the audio machine name would be (HEX codes):
7D 96 90 81 (i.e. 128dec+ 22dec for 2nd byte, and 128dec+ 16dec for 3rd byte).

If the request for identification is sent with the INPUT set as 3 or 4, the appropriate machine sends its software version number. Again, the reply would be the decimal value of the INPUT and OUTPUT - the INPUT representing the number in front of the decimal point, and the OUTPUT representing the number after it. For example, for version 3.5, the reply to the request to send the version number would be (HEX codes):
7D 83 85 81 (i.e. 128dec+ 3dec for 2nd byte, 128dec+ 5dec for 3rd byte).

If the OUTPUT is set as 1, then the ASCII coding of the lettering following the machine's name is sent. For example, for the VS-7588YC, the reply to the request to send the first suffix would be (HEX codes):
7D D9 C3 81 (i.e. 128dec+ ASCII for "Y"; 128dec+ ASCII for "C").

NOTE 14 - The number of inputs and outputs refers to the specific machine which is being addressed, not to the system. For example, if six 16X16 matrices are configured to make a 48X32 system (48 inputs, 32 outputs), the reply to the HEX code
3E 82 81 82 (ie. request the number of outputs)
would be HEX codes
7E 82 90 82
ie. 16 outputs

NOTE 15 - When the OVR bit (4th byte) is set, then the "video" commands have universal meaning. For example, instruction 1 (SWITCH VIDEO) causes all units (including audio, data, etc.) to switch. Similarly, if a machine is in "FOLLOW" mode, it performs any "video" instruction.

NOTE 16 - The reply to the "REQUEST WHETHER PANEL IS LOCKED" is as in NOTE 4 above, except that here the OUTPUT is assigned with the value 0 if the panel is unlocked, or 1 if it is locked.

10 Application Software Tools

This section defines the different application software tools used for the **VS-66HDCPxI**.

10.1 Control Methods

The following table describes the **VS-66HDCPxI** remote access methods:

Application Software Tool	Used for	Communication Method		
		ETH UDP Port 50000	ETH TCP Port 5000	Serial, RS-232
K-Router Plus	Matrix Switch control		V	V
Hercules , Hyper terminal	P3000 control prompt	COM module protocol access; MODEL?= VS-66HDCPxI-COM11	Matrix Switch protocol access; (MODEL?= VS-66HDCPxI)	Matrix Switch protocol access; MODEL?= VS-66HDCPxI
K-Lan	COM module configuration	V		

10.2 Firmware Upgrade

The following table describes the applications that need to be used for firmware upgrade:

Application Software Tool	Used for	Communication method
STC burning app	Matrix Switch FW upgrade	Serial, RS-232
K-Upload	COM module FW upgrade	ETH UDP port 50000

LIMITED WARRANTY

The warranty obligations of Kramer Electronics for this product are limited to the terms set forth below:

What is Covered

This limited warranty covers defects in materials and workmanship in this product.

What is Not Covered

This limited warranty does not cover any damage, deterioration or malfunction resulting from any alteration, modification, improper or unreasonable use or maintenance, misuse, abuse, accident, neglect, exposure to excess moisture, fire, improper packing and shipping (such claims must be presented to the carrier), lightning, power surges, or other acts of nature. This limited warranty does not cover any damage, deterioration or malfunction resulting from the installation or removal of this product from any installation, any unauthorized tampering with this product, any repairs attempted by anyone unauthorized by Kramer Electronics to make such repairs, or any other cause which does not relate directly to a defect in materials and/or workmanship of this product. This limited warranty does not cover cartons, equipment enclosures, cables or accessories used in conjunction with this product.

Without limiting any other exclusion herein, Kramer Electronics does not warrant that the product covered hereby, including, without limitation, the technology and/or integrated circuit(s) included in the product, will not become obsolete or that such items are or will remain compatible with any other product or technology with which the product may be used.

How Long Does this Coverage Last

Seven years as of this printing; please check our Web site for the most current and accurate warranty information.

Who is Covered

Only the original purchaser of this product is covered under this limited warranty. This limited warranty is not transferable to subsequent purchasers or owners of this product.

What Kramer Electronics will do

Kramer Electronics will, at its sole option, provide one of the following three remedies to whatever extent it shall deem necessary to satisfy a proper claim under this limited warranty:

1. Elect to repair or facilitate the repair of any defective parts within a reasonable period of time, free of any charge for the necessary parts and labor to complete the repair and restore this product to its proper operating condition. Kramer Electronics will also pay the shipping costs necessary to return this product once the repair is complete.
2. Replace this product with a direct replacement or with a similar product deemed by Kramer Electronics to perform substantially the same function as the original product.
3. Issue a refund of the original purchase price less depreciation to be determined based on the age of the product at the time remedy is sought under this limited warranty.

What Kramer Electronics will not do Under This Limited Warranty

If this product is returned to Kramer Electronics or the authorized dealer from which it was purchased or any other party authorized to repair Kramer Electronics products, this product must be insured during shipment, with the insurance and shipping charges prepaid by you. If this product is returned uninsured, you assume all risks of loss or damage during shipment. Kramer Electronics will not be responsible for any costs related to the removal or re-installation of this product from or into any installation. Kramer Electronics will not be responsible for any costs related to any setting up this product, any adjustment of user controls or any programming required for a specific installation of this product.

How to Obtain a Remedy under this Limited Warranty

To obtain a remedy under this limited warranty, you must contact either the authorized Kramer Electronics reseller from whom you purchased this product or the Kramer Electronics office nearest you. For a list of authorized Kramer Electronics resellers and/or Kramer Electronics authorized service providers, please visit our web site at www.kramerelectronics.com or contact the Kramer Electronics office nearest you.

In order to pursue any remedy under this limited warranty, you must possess an original, dated receipt as proof of purchase from an authorized Kramer Electronics reseller. If this product is returned under this limited warranty, a return authorization number, obtained from Kramer Electronics, will be required. You may also be directed to an authorized reseller or a person authorized by Kramer Electronics to repair the product.

If it is decided that this product should be returned directly to Kramer Electronics, this product should be properly packed, preferably in the original carton, for shipping. Cartons not bearing a return authorization number will be refused.

Limitation on Liability

THE MAXIMUM LIABILITY OF KRAMER ELECTRONICS UNDER THIS LIMITED WARRANTY SHALL NOT EXCEED THE ACTUAL PURCHASE PRICE PAID FOR THE PRODUCT. TO THE MAXIMUM EXTENT PERMITTED BY LAW, KRAMER ELECTRONICS IS NOT RESPONSIBLE FOR DIRECT, SPECIAL, INCIDENTAL OR CONSEQUENTIAL DAMAGES RESULTING FROM ANY BREACH OF WARRANTY OR CONDITION, OR UNDER ANY OTHER LEGAL THEORY. Some countries, districts or states do not allow the exclusion or limitation of relief, special, incidental, consequential or indirect damages, or the limitation of liability to specified amounts, so the above limitations or exclusions may not apply to you.

Exclusive Remedy

TO THE MAXIMUM EXTENT PERMITTED BY LAW, THIS LIMITED WARRANTY AND THE REMEDIES SET FORTH ABOVE ARE EXCLUSIVE AND IN LIEU OF ALL OTHER WARRANTIES, REMEDIES AND CONDITIONS, WHETHER ORAL OR WRITTEN, EXPRESS OR IMPLIED. TO THE MAXIMUM EXTENT PERMITTED BY LAW, KRAMER ELECTRONICS SPECIFICALLY DISCLAIMS ANY AND ALL IMPLIED WARRANTIES, INCLUDING, WITHOUT LIMITATION, WARRANTIES OF MERCHANTABILITY AND FITNESS FOR A PARTICULAR PURPOSE. IF KRAMER ELECTRONICS CANNOT LAWFULLY DISCLAIM OR EXCLUDE IMPLIED WARRANTIES UNDER APPLICABLE LAW, THEN ALL IMPLIED WARRANTIES COVERING THIS PRODUCT, INCLUDING WARRANTIES OF MERCHANTABILITY AND FITNESS FOR A PARTICULAR PURPOSE, SHALL APPLY TO THIS PRODUCT AS PROVIDED UNDER APPLICABLE LAW.

IF ANY PRODUCT TO WHICH THIS LIMITED WARRANTY APPLIES IS A "CONSUMER PRODUCT" UNDER THE MAGNUSON-MOSS WARRANTY ACT (15 U.S.C.A. §2301, ET SEQ.) OR OTHER APPLICABLE LAW, THE FOREGOING DISCLAIMER OF IMPLIED WARRANTIES SHALL NOT APPLY TO YOU, AND ALL IMPLIED WARRANTIES ON THIS PRODUCT, INCLUDING WARRANTIES OF MERCHANTABILITY AND FITNESS FOR THE PARTICULAR PURPOSE, SHALL APPLY AS PROVIDED UNDER APPLICABLE LAW.

Other Conditions

This limited warranty gives you specific legal rights, and you may have other rights which vary from country to country or state to state.

This limited warranty is void if (i) the label bearing the serial number of this product has been removed or defaced, (ii) the product is not distributed by Kramer Electronics or (iii) this product is not purchased from an authorized Kramer Electronics reseller. If you are unsure whether a reseller is an authorized Kramer Electronics reseller, please visit our Web site at www.kramerelectronics.com or contact a Kramer Electronics office from the list at the end of this document.

Your rights under this limited warranty are not diminished if you do not complete and return the product registration form or complete and submit the online product registration form. Kramer Electronics thanks you for purchasing a Kramer Electronics product. We hope it will give you years of satisfaction.



For the latest information on our products and a list of Kramer distributors, visit our Web site where updates to this user manual may be found.

We welcome your questions, comments, and feedback.

Web site: www.kramerelectronics.com

E-mail: info@kramerel.com



SAFETY WARNING

Disconnect the unit from the power supply before opening and servicing



P/N: 2900-300018



Rev: 9