



USER MANUAL

MODELS:

KDS-17EN / KDS-17DEC

4K60 4:4:4 AVoIP Encoder / Decoder



1 Contents

1	Contents	2
2	Introduction	3
2.1	<i>Getting Started</i>	3
2.2	<i>Overview</i>	4
2.3	<i>Typical Applications</i>	5
2.4	<i>Controlling your KDS-17 device</i>	5
3	Defining KDS-17EN	6
4	Defining KDS-17DEC	8
5	Mounting the KDS-17 Devices	10
6	Connecting the KDS-17 Devices	12
6.1	<i>Configuring the Network Switch</i>	14
6.2	<i>Installing the Kramer recommended SFP transceiver</i>	15
6.3	<i>Connecting the Audio/Input Output</i>	15
6.4	<i>Connecting to a KDS-17 device with RS-232</i>	16
7	Operating and Controlling KDS-17 Devices	17
7.1	<i>Using the LCD Display</i>	17
7.2	<i>Operating via Ethernet</i>	19
8	Using KDS-17EN Embedded Web Pages	24
8.1	<i>To Browse the KDS-17EN Web Pages</i>	24
8.2	<i>Dashboard: Overview of Streaming</i>	25
8.3	<i>AV Settings: Define Video and Audio Output</i>	28
8.4	<i>EDID: Setting Display Metadata</i>	31
8.5	<i>Device Settings: General, Network, Time</i>	32
8.6	<i>Security: Passwords, HTTPS, 802.1X and AES256</i>	36
8.7	<i>Gateway: CEC, RS-232 and IR definitions</i>	40
8.8	<i>Diagnostics: Status and Connections</i>	43
8.9	<i>About</i>	45
8.10	<i>Upgrading Firmware</i>	46
9	Using KDS-17DEC Embedded Web Pages	47
9.1	<i>To Browse the KDS-17DEC Web Pages</i>	47
9.2	<i>Dashboard: Overview of Streaming</i>	48
9.3	<i>AV Settings: Video, OSD, KVM, Video Wall & Overlay</i>	50
9.4	<i>Device Settings: General, Network, Time</i>	62
9.5	<i>Security: Passwords, HTTPS and 802.1X</i>	66
9.6	<i>Gateway: CEC, RS-232 and IR definitions</i>	70
9.7	<i>Diagnostics: Status and Connections</i>	73
9.8	<i>About</i>	75
9.9	<i>Upgrading Firmware</i>	76
10	Defining Dante Audio as an Audio Source or Destination	77
10.1	<i>Defining Dante input to the KDS-17EN encoder</i>	77
10.2	<i>Defining Dante output from the KDS-17DEC decoder</i>	77
10.3	<i>Using Dante Software</i>	77
11	Technical Specifications	80
11.1	<i>KDS-17EN Specifications</i>	80
11.2	<i>KDS-17DEC Specifications</i>	81
11.3	<i>Default Communication Parameters</i>	82
12	Protocol 3000	83
12.1	<i>Understanding Protocol 3000</i>	83
12.2	<i>Protocol 3000 Commands</i>	84
12.3	<i>Result and Error Codes</i>	103
13	Warranty	104

2 Introduction

Welcome to Kramer Electronics! Since 1981, Kramer Electronics has been providing a world of unique, creative, and affordable solutions to the vast range of problems that confront the video, audio, presentation, and broadcasting professional on a daily basis. In recent years, we have redesigned and upgraded most of our line, making the best even better!

2.1 Getting Started

We recommend that you:

- Unpack the equipment carefully and save the original box and packaging materials for possible future shipment.
- Review the contents of this user manual.



Go to <http://www.kramerav.com/downloads/kds-17en> or <http://www.kramerav.com/downloads/kds-17dec> to check for up-to-date user manuals, application programs, and to check if firmware upgrades are available (where appropriate).

2.1.1 Achieving Best Performance

- Use only good quality connection cables (we recommend Kramer high-performance, high-resolution cables) to avoid interference, deterioration in signal quality due to poor matching, and elevated noise levels (often associated with low quality cables).
- Do not secure the cables in tight bundles or roll the slack into tight coils.
- Avoid interference from neighboring electrical appliances that may adversely influence signal quality.
- Position your Kramer **KDS-17EN / KDS-17DEC** away from moisture, excessive sunlight and dust.

2.1.2 Safety Instructions



Caution:

- This equipment is to be used only inside a building. It may only be connected to other equipment that is installed inside a building.
- For products with relay terminals and GPIO ports, please refer to the permitted rating for an external connection, located next to the terminal or in the User Manual.
- There are no operator serviceable parts inside the unit.



Warning:

- If using a power cord, only use the Kramer approved power cord.

2.1.3 Recycling Kramer Products

The Waste Electrical and Electronic Equipment (WEEE) Directive 2002/96/EC aims to reduce the amount of WEEE sent for disposal to landfill or incineration by requiring it to be collected and recycled. To comply with the WEEE Directive, Kramer Electronics has made arrangements with the European Advanced Recycling Network (EARN) and will cover any costs of treatment, recycling and recovery of waste Kramer Electronics branded equipment on arrival at the EARN facility. For details of Kramer's recycling arrangements in your particular country go to our recycling pages at www.kramerav.com/quality/environment.

2.2 Overview

Congratulations on purchasing your Kramer **KDS-17EN** 4K60 4:4:4 AVoIP Encoder / **KDS-17DEC** 4K60 4:4:4 AVoIP Decoder.

KDS-17 advanced encoder/decoders stream 4K video signals via Ethernet over copper cable in unicast (one-to-one) or multicast (one-to-many) configurations.

KDS-17EN and **KDS-17DEC** provide:

- High quality video and audio streaming
- Outstanding end-user experience
- Ideal for large-scale deployments
- Simple planning and rollout

2.2.1 Outstanding end-user experience

Present video in superb 4K60 4.4.4 resolution, with best-in-class digital audio. With KDS-17, every visual detail and every nuance of sound comes through super-clearly. Enjoy extensive control of video walls, advanced connectivity options, and a wide choice of inputs/outputs and settings options.

2.2.2 Ideal for large-scale deployments

Provide a high-performance solution fine tuned to the needs of large enterprise, education and government sites, with integrated advanced management capabilities and support for many simultaneous video streams.

2.2.3 Easy planning and deployment

Easily and confidently integrate the AV solution into any IP network. Create A/V-enabled spaces of varying sizes swiftly and effortlessly, even without prior AV expertise. KDS-17 is very bandwidth-efficient, allowing you to leverage your IT infrastructure without perceptible network performance disruptions. Use of the existing IT network and Ethernet cabling, simplified switch configurations, and reduced dependence on skilled technicians save deployment time and cost.

2.3 Typical Applications

KDS-17EN / KDS-17DEC are ideal for the following typical applications:

- Real-time essential installations such as command and control rooms.
- Large scale AV content sharing installations using existing wires and infrastructure in corporate offices and government applications.
- AV distribution systems with one or more sources and multiple displays in schools, universities, and public venues.
- AV installations where low latency KM/KVM capabilities are required.

2.4 Controlling your KDS-17 device

Control your KDS-17 device directly via Navigation buttons, or via:

- The Ethernet using built-in user-friendly web pages.
- Protocol commands.

3 Defining KDS-17EN

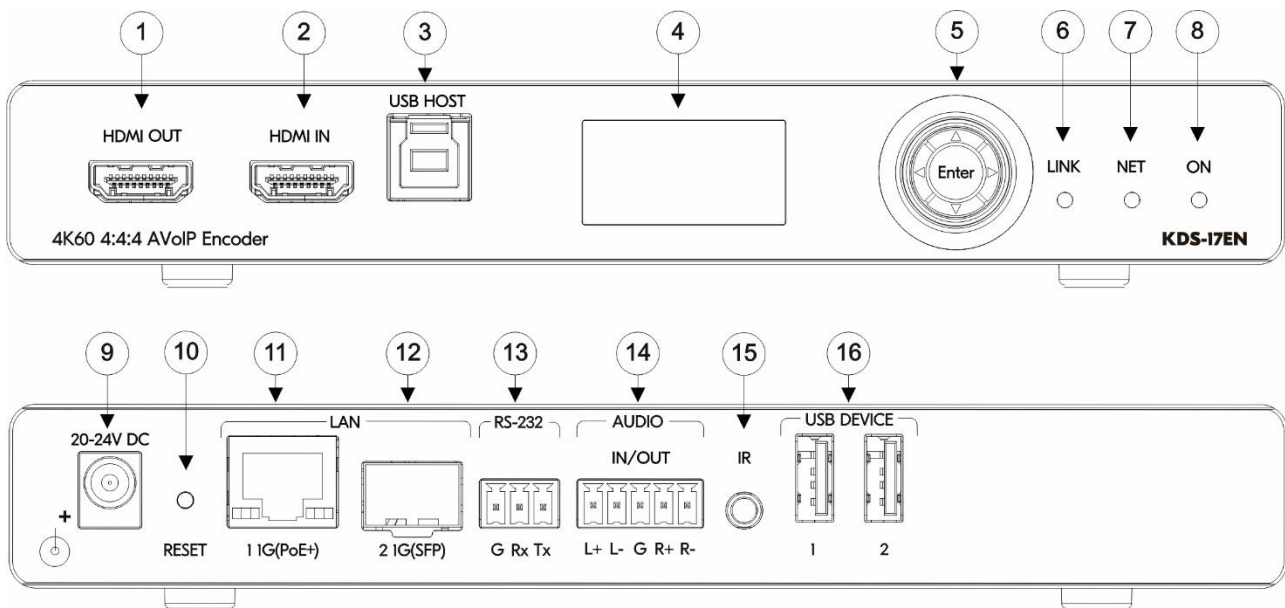

Figure 1: KDS-17EN 4K60 4:4:4 AVoIP Encoder

#	Feature	Function	
1	HDMI OUT Connector	Connect to loop the signal.	
2	HDMI IN Connector	Connect to an HDMI source.	
3	HOST USB Type B Port	Connect to a USB host, for example, a PC for KVM/USB support.	
4	LCD Display	Use for device configuration such as unique channel/AV stream setting.	
5	Menu Navigation Button	◀	Press to return to the previous menu.
		▶	Press to go to the next menu.
		▲	Press to move up to the next configuration parameter.
		▼	Press to move down to the next configuration parameter.
		Enter	Press to enter the menu and to accept changes.
6	LINK LED	Lights Green	A link is established from KDS-17EN to KDS-17DEC and is transmitting A/V signals.
		Flashes Green	HDMI input is detected, but no valid AV signal is output.
		Off	No HDMI input is detected.
7	NET LED	Off	No IP address is acquired.
		Lights Green	A valid IP address has been acquired.
		Flashes Green Very Fast	When a device identification command was received (Find me), flashes for 60 seconds.
		Lights Yellow	No DHCP found, device falls back to IP address in subnet range 192.168.0.0/16.
		Lights Red	Security is blocking IP access.
8	ON LED	Lights Green	Device power is on.
		Flashes Green Fast	Firmware is downloaded in the background.
		Flashes Green Very Fast	A device identification command is sent (Find me), flashes for 60 seconds.
		Lights Yellow	Device falls back to default IP address (192.168.1.39).
		Lights Red	Security is blocking IP access.
8	ON LED	Flashes Red	On fallback address acquiring, flashes continuously in a slow 0.5/10 second cadence.
9	20-24V DC Connector	Connect the optional 20-24V DC power adapter (purchased separately).	

#	Feature	Function
10	RESET Recessed Button	Press and hold for 10 seconds to reset the device to factory default values. All LEDs flash.
11	LAN 1: 1G(PoE+) RJ-45 Port	Connect to the LAN. KDS-17EN is powered by PoE+ (power over Ethernet) delivered through the LAN PoE+ port, unless the optional 20-24V DC power adapter is attached. Unicast: Connect for streaming either directly to a decoder or via LAN. Multicast: Connect to multiple decoders.
12	LAN 2: 1G SFP OUT IN Connector	Plug in an SFP (Small Form Factor Pluggable) optical or copper transceiver for streaming over cable.
13	RS-232 3-pin Terminal Block Connector	Connect to an RS-232 device to use as a Gateway and bi-directional signal extension (even when no AV signal is extended).
14	AUDIO IN/OUT 5-pin Terminal Block Connector	Connect to a balanced analog stereo audio source/acceptor (must be either in or out, not both).
15	IR 3.5 Mini Jack	Connect to an IR sensor or emitter for bi-directional signal extension (even when no AV signal is extended). Expected voltage for IR receiver - (3.3V).
16	USB Type A Charging Ports (1 and 2)	Connect to USB devices, for example, to a speakerphone and webcam.

4 Defining KDS-17DEC

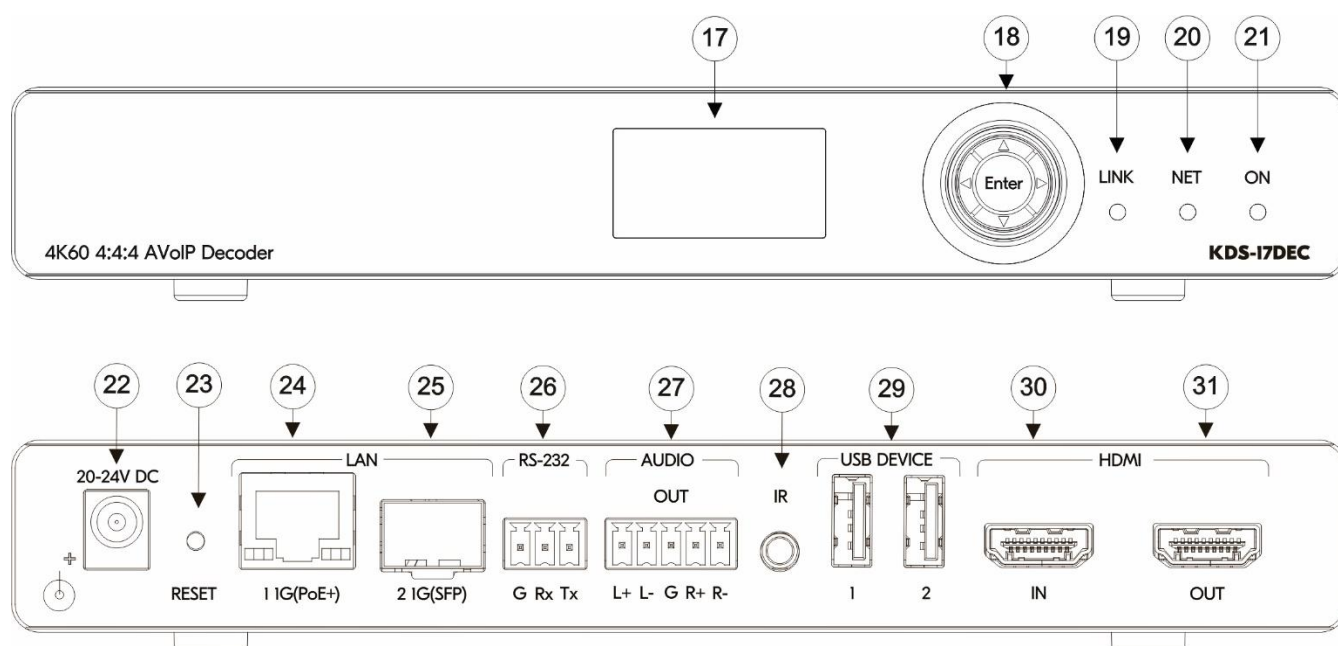

Figure 2: KDS-17DEC 4K60 4:4:4 AVoIP Decoder

#	Feature	Function	
17	LCD Display	Use for device configuration such as unique channel/AV stream setting.	
18	Menu Navigation Button	◀	Press to return to the previous menu.
		▶	Press to go to the next menu.
		▲	Press to move up to the next configuration parameter.
		▼	Press to move down to the next configuration parameter.
		Enter	Press to accept changes.
19	LINK LED	Lights Green	A link is established from KDS-17DEC to KDS-17EN and A/V signals are being received.
		Flashes Green	A link is established, but no valid AV signal is detected.
		Off	Input streaming has been disabled.
20	NET LED	Lights Green	A valid IP address has been acquired.
		Flashes Green Very Fast	When a device identification command is sent (Find me), flashes for 60 seconds.
		Lights Yellow	No DHCP found, device falls back to IP address in subnet range 192.168.0.0/16.
		Lights Red	Security is blocking IP access.
		Off	No IP address is acquired.
21	ON LED	Lights Green	Device power is on.
		Flashes Green Fast	Firmware is downloaded in the background.
		Flashes Green Very Fast	A device identification command is sent (Find me), flashes for 60 seconds.
		Lights Yellow	Device falls back to default IP address (192.168.1.40).
		Lights Red	Security is blocking IP access.
		Flashes Red	On fallback address acquiring, flashes continuously in a slow 0.5/10sec cadence.
22	20-24V DC Connector	Connect to the optional 20-24V DC power adapter (purchased separately).	
23	RESET Recessed Button	Press and hold for 10 seconds to reset the device to its factory default values. All LEDs flash.	

#	Feature	Function
24	LAN 1: 1G(PoE+) RJ-45 Port	Connect to the LAN. KDS-17DEC is powered by PoE+ (power over Ethernet) delivered through the LAN PoE+ port, unless the optional 20-24V DC power adapter is attached. Unicast: Connected for streaming directly from the encoder. Multicast: Encoder is streaming to multiple decoders.
25	LAN 2: 1G SFP OUT IN	Plug in an SFP (Small Form Factor Pluggable) optical or copper transceiver for Ethernet traffic over cable.
26	RS-232 3-pin Terminal Block Connector	Connect to an RS-232 device to use as a Gateway and bi-directional signal extension (even when no AV signal is extended).
27	AUDIO OUT 5-pin Terminal Block Connector	Connect to a balanced analog stereo audio source/acceptor.
28	IR 3.5 Mini Jack	Connect to an IR sensor or emitter for bi-directional signal extension (even when no AV signal is extended). Expected voltage for IR receiver - (3.3V).
29	USB Type A Charging Ports (1 and 2)	Connect to USB devices, for example, to a speakerphone and webcam.
30	HDMI IN Connector	Connect to an HDMI source.
31	HDMI OUT Connector	Connect to an HDMI acceptor.

5 Mounting the KDS-17 Devices

Before installing the devices, verify that the environment is within the recommended range:



- Operation temperature – 0° to 40°C (32 to 104°F).
- Storage temperature – -40° to +70°C (-40 to +158°F).
- Humidity – 10% to 90%, RHL non-condensing.



Caution:

- Mount **KDS-17EN** and **KDS-17DEC** before connecting any cables or power.



Warning:

- Ensure that the environment (e.g., maximum ambient temperature & air flow) is compatible for the device.
- Avoid uneven mechanical loading.
- Appropriate consideration of equipment nameplate ratings should be used for avoiding overloading of the circuits.
- Reliable earthing of rack-mounted equipment should be maintained.
- Maximum mounting height for the device is 2 meters.

Mount KDS-17EN / KDS-17DEC in a rack:

- Use the recommended rack adapter (see www.kramerav.com/product/KDS-17EN).

1. Unfasten the knobs to remove the open panel.

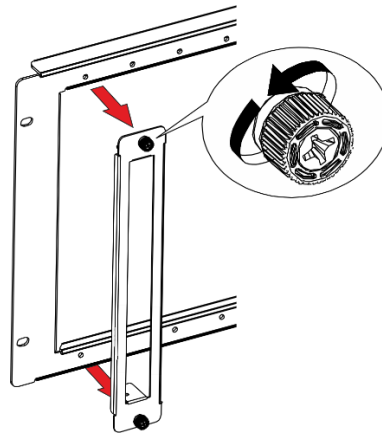

2. Slide the device into the panel opening.

3. Attach the device to the panel using 4 screws (2 on each side to secure the device to the panel).

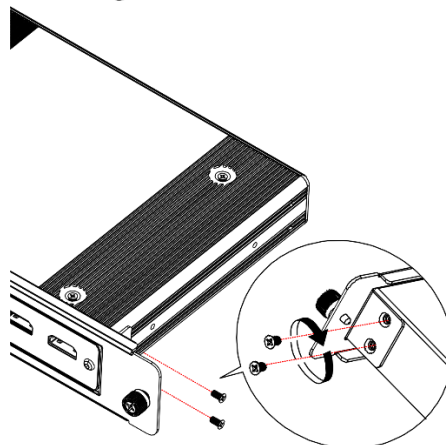

4. Slide the open panel with the device into the rack opening.

5. Turn the knob to secure panel to rack.

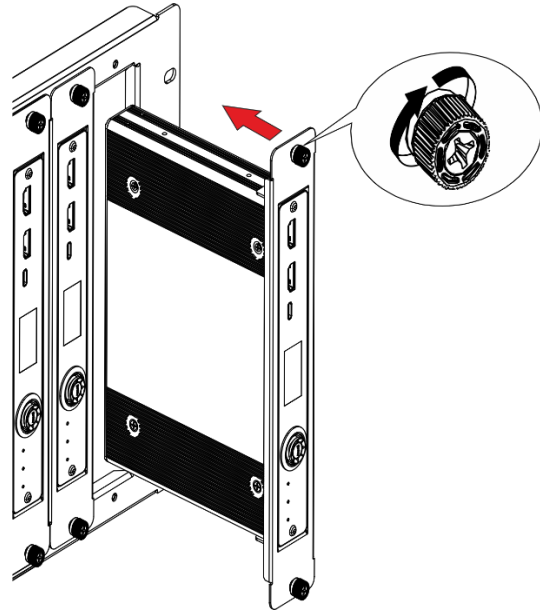

Mount the on a surface using one of the following methods:

- Attach the rubber feet and place the unit on a flat surface.
- Fasten a bracket (included) on each side of the unit and attach it to a flat surface.

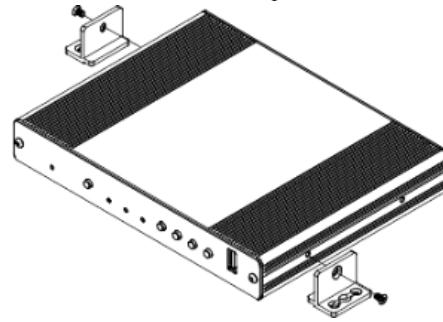

For more information go to www.kramerav.com/downloads/KDS-17EN or <http://www.kramerav.com/downloads/KDS-17DEC>

6 Connecting the KDS-17 Devices



By-default, KDS-17 devices use PoE for power. An optional power adapter can be purchased to connect the product to the mains electricity.

Always switch off the power to a device before connecting it to your **KDS-17EN** or **KDS-17DEC**. After connecting your devices, connect their power and then switch on the power to each device.

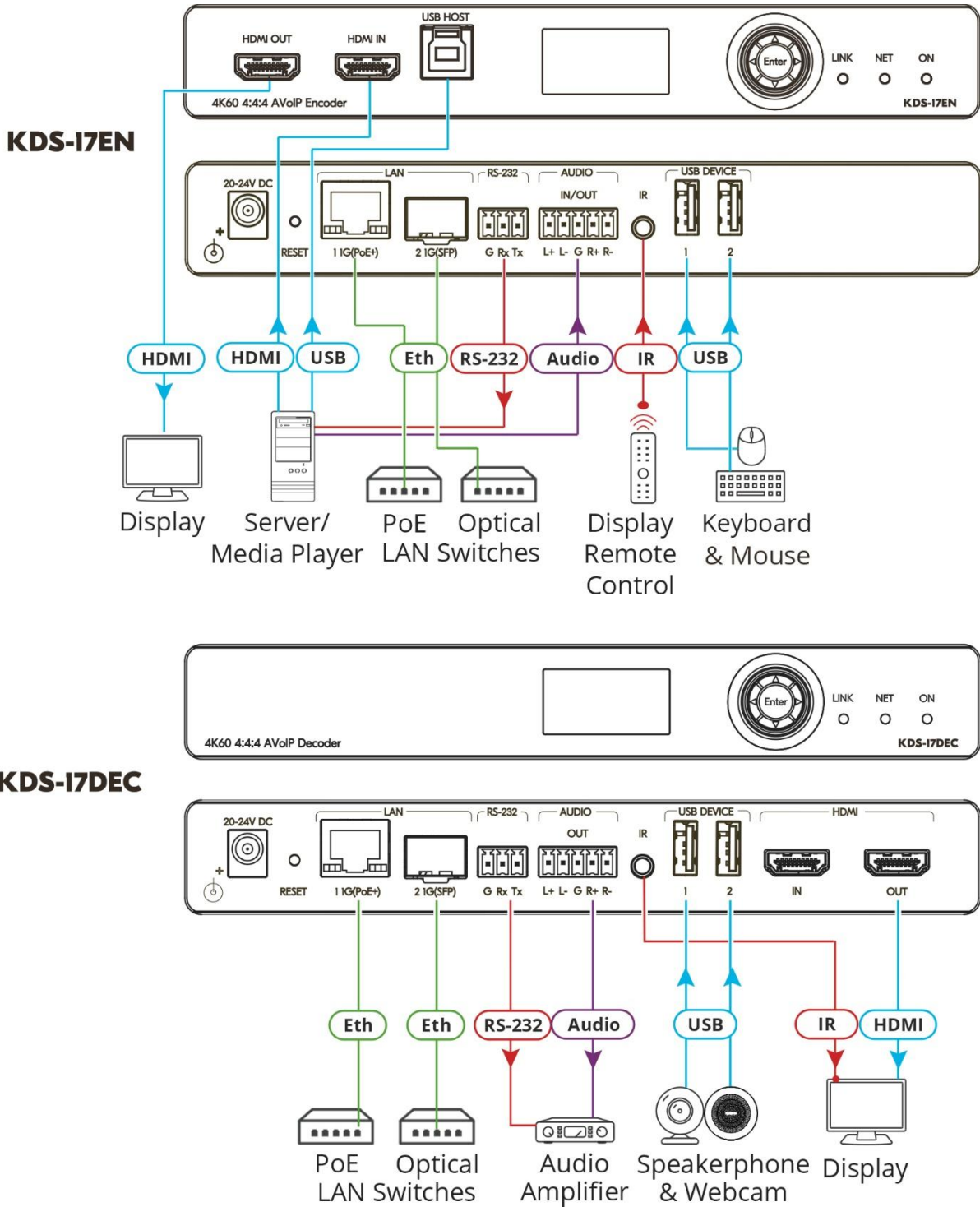

Figure 3: Connecting the KDS-17EN to a KDS-17DEC

To connect KDS-17EN as illustrated in the example in [Figure 3](#):

1. Connect an HDMI source (for example, a server or a media player) to the HDMI IN connector (2) on the **KDS-17EN**.
2. Connect a balanced stereo audio source (for example, the server audio connector) to the AUDIO IN/OUT 5-pin terminal block connector (14) on the **KDS-17EN**.
3. Connect the LAN MEDIA 1G(PoE) RJ-45 port (11) on the **KDS-17EN** to the LAN MEDIA 1G(PoE) RJ-45 port (24) on the **KDS-17DEC** via a LAN switch.
4. Connect the HDMI OUT connector (31) on the **KDS-17DEC** to an HDMI acceptor (for example, a display).

5. Connect the AUDIO OUT 5-pin terminal block connector (27) on the **KDS-17DEC** to a balanced stereo audio acceptor (for example, an audio amplifier).
6. Connect the USB ports:
 - On **KDS-17EN**, connect a laptop or media center to the USB HOST port (3).
 - On **KDS-17DEC**, connect a mouse and a keyboard to the two USB type A ports (29).
7. Control the display

play connected to **KDS-17DEC** from the encoder side via IR:

- On **KDS-17EN**, connect an IR sensor cable to the IR 3.5mm mini jack (15).
 - On **KDS-17DEC**, connect the IR 3.5mm mini jack (28) to an emitter cable and attach the emitter side to the IR sensor of the display.
8. Connect RS-232 3-pin terminal block connectors:
 - On the **KDS-17EN**, connect the RS-232 port (13) to a laptop/controller.
 - On the **KDS-17DEC**, connect RS-232 (26) to the display.



RS-232 bidirectional signals can be sent between the display and the laptop connected to the HDMI OUT connector on the **KDS-17DEC**.

6.1 Configuring the Network Switch

Before setting the system, make sure that your AV over IP network switch meets the following minimum requirements:

- IGMP Snooping – On.
- IGMP Querier – On.
- IGMP Immediate/Fast Leave – On.
- Unregistered Multicast Filtering – On.
- Jumbo frames – Enable (when AES256 full encryption is required).

6.2 Installing the Kramer recommended SFP transceiver

1. Remove the currently installed transceiver: Pull down the bale clasp and insert the dust plug. Store the transceiver in a safe place.
2. Make sure the bale clasp of the new transceiver is pushed up, in the closed position.
3. Insert the new transceiver into the SFP port and push it in until it clicks.
4. Remove the dust cap and store it in a safe place for future use.

Warning: Connecting the SFP connector to an LC(APC) fiber connector may cause poor performance and damage the connector!

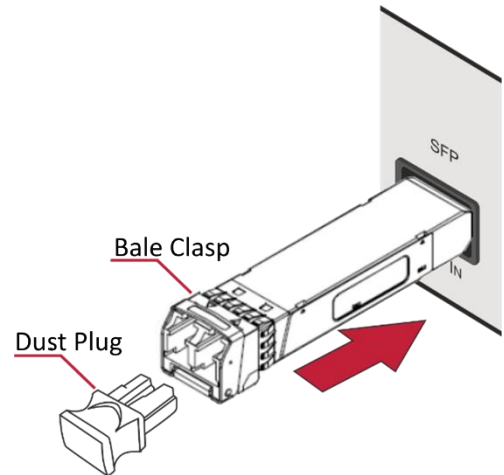

Warning: Class 1 Laser Product

Invisible laser radiation present.

Avoid long-term viewing of laser.

Avoid the use of magnifying viewing aids or instruments (such as binoculars, telescopes, microscopes and magnifying lenses, but not spectacles or contact lenses).

Avoid placing optical devices in the emitted beam that could cause the concentration of the laser radiation to be increased.



To achieve specified extension distances, use the recommended Kramer cables available at <http://www.kramerav.com/product/kds-17en> or <http://www.kramerav.com/product/kds-17dec>. Using third-party cables may cause damage!

6.3 Connecting the Audio/Input Output

The following are the pinouts for connecting the input/output to a balanced or unbalanced stereo audio acceptor:



Figure 4: Connecting to a Balanced Stereo Audio Source/Acceptor

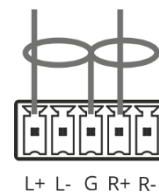

Figure 5: Connecting to an Unbalanced Stereo Audio Acceptor

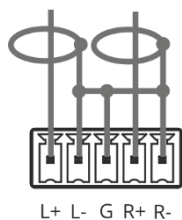

Figure 6: Connecting an Unbalanced Stereo Audio Source to the Balanced Input

6.4 Connecting to a KDS-17 device with RS-232

KDS-17EN and **KDS-17DEC** can transmit or receive data via the RS-232 connection (13) and relay that data to the remote encoder or decoder.

KDS-17 devices feature an RS-232 3-pin terminal block connector which can be used to transmit RS-232 data between the encoder and decoder and to remotely control connected devices.

Connect the RS-232 terminal block on the rear panel of the **KDS-17** device to a PC/controller, as follows:

From the RS-232 9-pin D-sub serial port connect:

- Pin 2 to the TX pin on the **KDS-17** RS-232 terminal block
- Pin 3 to the RX pin on the **KDS-17** RS-232 terminal block
- Pin 5 to the G pin on the **KDS-17** RS-232 terminal block

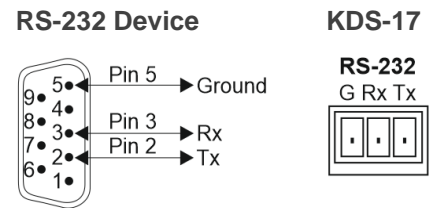

7 Operating and Controlling KDS-17 Devices

7.1 Using the LCD Display

Connect the KDS-17 device's LAN 1 port to a LAN switch with PoE+ (power over ethernet). If PoE is unavailable, connect the device to the 20-24V DC power adapter and connect the adapter to the mains electricity. The LEDs light white while the device boots and then the ON and NET LEDs light green or yellow, indicating that the device is on and has a valid IP address.

7.1.1 Using the Menu Navigation button

Use the menu navigation button to view and change device parameters in the LCD display.



KDS-17EN and KDS-17DEC have slightly different menus.

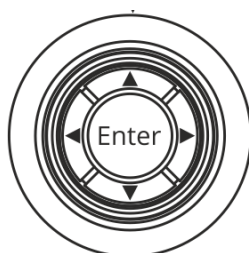

Figure 7: The Menu Navigation button

- Up/down arrows – Move to the previous/next menu item.
- Left/right arrow – Open the previous/next level menu.
- Enter button – Select a menu option / accept and save changes.
If the LCD display is blank a single press of Enter will cause it to display the connected channel number, a second press of Enter opens the Main Menu.

Use Enter to accept and save changes in the MAIN MENU > DEV SETTINGS.

7.1.2 Using the KDS-17 LCD Display Menu

To access the LCD display menu, press **Enter** on the **Menu Navigation** button: The Main Menu is displayed.

The **Main Menu** has 3 sub-menus (listed below):

- An asterisk (*) indicates the active option.
- **Changes are made in MAIN MENU > DEV SETTINGS.** Press **Enter** on an option to make it active.

Main Menu Item	Sub-menu Options	Output
1. DEV STATUS	CONTROL STAT	The IP address, subnet mask and gateway address used for streamed P3K API, RS-232 and IR data.
	STREAM STAT	The IP address, subnet mask and gateway address used for streamed AV content.
	DANTE STAT	The IP address, subnet mask and gateway address used for streamed DANTE digital audio.
	INPUT (encoder) / OUTPUT (decoder)	<ul style="list-style-type: none"> I/O Resolution if a signal is input or output. HDCP status of the input/output. (same for both devices)
	Temperature	Device temperature.
2. DEV INFO		FW: Firmware version BL: Build version HW: Hardware version.
3. DEV SETTINGS Use this option to change settings. Unavailable on devices provisioned by the Panta Rhei AVoIP Manager.	EDID (encoder only)	Lists the stored EDIDs (maximum 8).
	HDCP (encoder only)	ON or OFF .
	CH DEFINE (encoder only)	Channel ID of the output stream. To change the channel use the up/down arrows to change each digit, press Enter to confirm the final number.
	INPUT (decoder only)	NETWORK (encoder stream) or HDMI . To change the input source, use the up/down arrows and press Enter to confirm.
	RESOLUTION (decoder only)	PASSTHROUGH (uses the source HDMI resolution) NATIVE (uses the EDID's resolution) Specific resolution* (see the list below) To change the selection, use the up/down arrows and press Enter to confirm.
	RESET IP	Enable/disable DHCP. If DHCP is enabled, the device will prompt you to save and reboot. If DHCP is disabled, the default IP is shown and can be edited using the arrow keys to select digits.

*Selectable resolutions for the KDS-17DEC:

3840X2160P60	1920X1200	1360X768
3840X2160P50	1920X1080P60	1280X1024
3840X2160P30	1920X1080P50	1280X768
3840X2160P25	1680X1050	1280X720P60

Not available on devices provisioned by the AVoIP Manager.

7.2 Operating via Ethernet

7.2.1 Allocating an IP Address to the Device

By default, DHCP is enabled, and assigns an IP address to the devices. If a DHCP Server is not available, for example, if LAN 1 is connected directly to a laptop, the device will try to allocate the default IP address of 192.168.1.39 (encoder) or 192.168.1.40 (decoder). If the default IP address is unavailable, the system searches for a random unique IP in the range of 192.168.X.Y. The allocated IP address can be viewed in the LCD Display (see instructions below).

 If both these options fail, then follow the instructions in (see [Connecting Ethernet Port Directly to a PC](#) on page 21).

To view the allocated IP address on the LCD Display

1. Connect **LAN 1** to a LAN switch with PoE+ (power over ethernet). The LEDs light white while the device boots and then the ON and NET LEDs light green or yellow, indicating that the device is on and has a valid IP address.
2. Use the **Menu Navigation** button to view the assigned IP address on the LCD screen:
 - a. Click **Enter** to display the channel number and **Enter** again, to display the LCD's MAIN MENU.
 - b. Use the navigation arrows to select DEV STATUS > LAN1 STATUS and the device IP is displayed.

7.2.2 Setting the Channel Number

Each encoder requires a unique channel number, and the connected decoders must be tuned to the encoder's channel. You can set the channel number via the LCD screen menu or the embedded web pages.

To set the channel number in the LCD Display's menu:

1. Connect **LAN 1** to a LAN switch with PoE+ (power over ethernet). The LEDs light white as the device boots and then the ON and NET LEDs light green or yellow, indicating that the device is on and has a valid IP address.
2. Use the **Menu Navigation** button to set the channel number with the LCD screen: Press Enter to display the channel number and Enter again, to display the LCD's MAIN MENU.
3. Use the arrows to select
 - encoder - DEV SETTINGS > CH DEFINE
 - decoder - DEV SETTINGS > CH SELECT.
4. A cursor will flash under the first digit of the channel number. Use the up/down arrow keys to change the digit and the right arrow to move to the next digit. Press Enter to save your selection.
5. The channel ID must be the same on both devices.

To set the channel number in the embedded web pages (if not using the LCD Display)

1. Find the device's IP address (see **Allocating an IP address** in the previous page).
2. Enter the IP address in the browser on a computer connected to the same network as the device (or on the computer to which the device is connected).
3. In the **Main** page (Dashboard tab) set the **Channel ID**.

7.2.3 Accessing the Embedded Web Pages

The embedded web pages are an HTML user interface stored inside the device.

1. The embedded web pages are accessed by entering the device's IP address in a browser (on a computer) connected to the same network as the device.
2. If you don't know the device's IP address, see [Allocating an IP Address to the Device](#) on page [19](#).
3. If security is enabled, enter the Password (default admin).

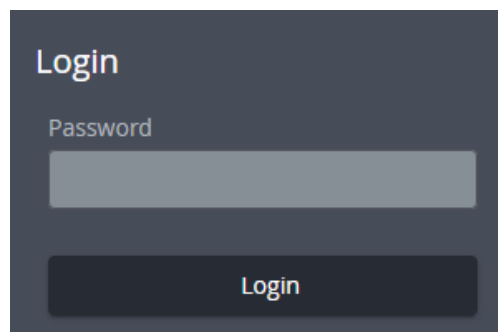

Figure 8: Login Window

7.2.4 Connecting Ethernet Port Directly to a PC

You can connect the Ethernet port of a **KDS-17 device** directly to the Ethernet port on your PC using LAN 1 (crossover cable with RJ-45 connectors).



This type of connection is recommended for identifying **KDS-17EN** or **KDS-17DEC** with the factory configured default IP addresses.

After connecting the device to the Ethernet port, configure your PC as follows:

1. Click **Start > Settings > Network and Internet**.
2. Click **Change Adapter Settings**.
3. Highlight the network adapter you want to use to connect to the device and click **Change settings of this connection**.

The Local Area Connection Properties window for the selected network adapter appears as shown in [Figure 9](#).

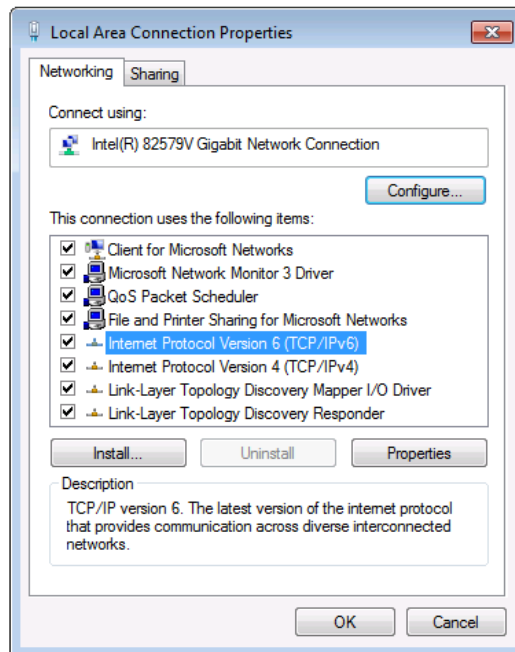

Figure 9: Local Area Connection Properties Window

4. Highlight either **Internet Protocol Version 6 (TCP/IPv6)** or **Internet Protocol Version 4 (TCP/IPv4)** depending on the requirements of your IT system.
5. Click **Properties**.

The Internet Protocol Properties window relevant to your IT system appears as shown in [Figure 10](#) or [Figure 11](#).

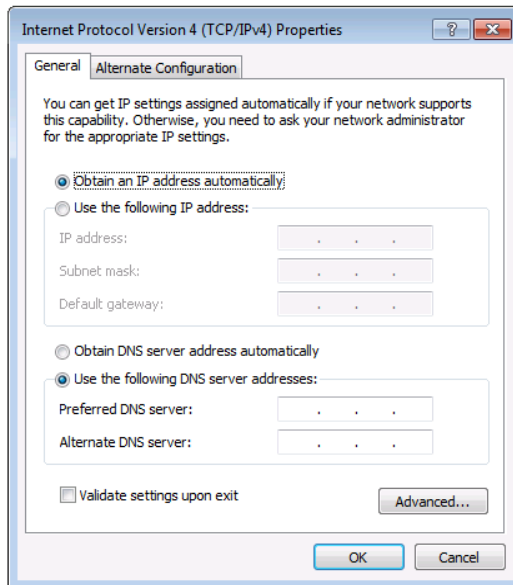

Figure 10: Internet Protocol Version 4 Properties Window

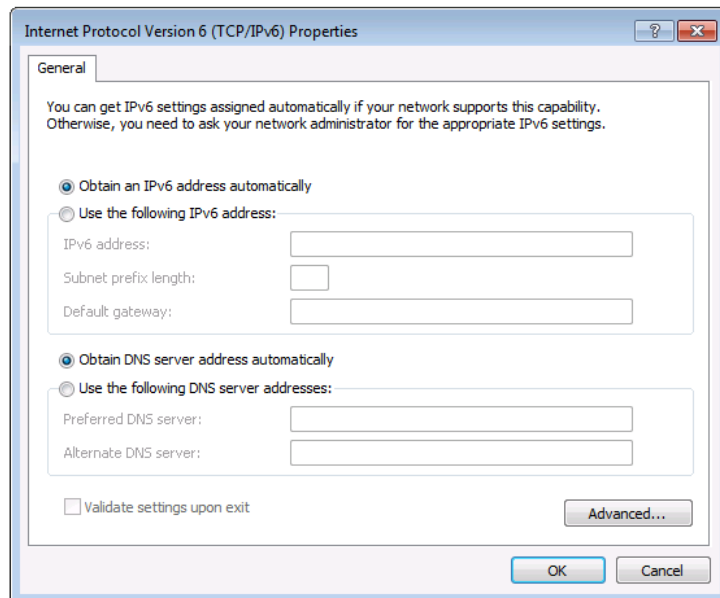

Figure 11: Internet Protocol Version 6 Properties Window

6. Select **Use the following IP Address** for static IP addressing and fill in the details as shown in [Figure 12](#).

For TCP/IPv4 you can use any IP address in the range 192.168.1.1 to 192.168.1.255 (excluding 192.168.1.39 and 192.168.1.40) that is provided by your IT department.

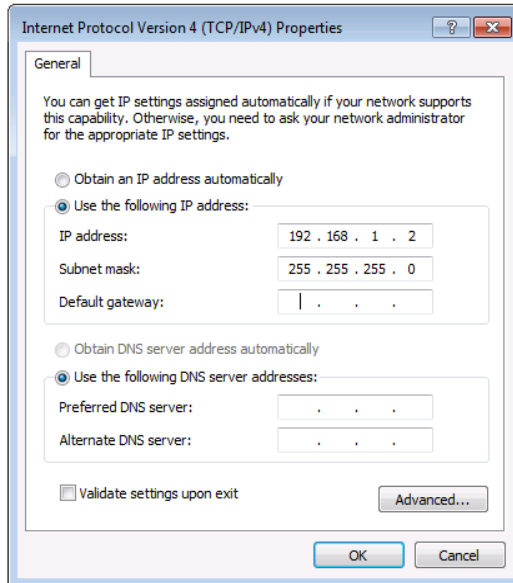

Figure 12: Internet Protocol Properties Window

7. Click **OK**.
8. Click **Close**.

7.2.5 Connecting the Ethernet Ports

You can connect the Ethernet ports of **KDS-17EN** and **KDS-17DEC** to the Ethernet port on a network hub/switch (they must both be connected to the same network) or connect them directly to one another using a cable with RJ-45 connectors.

7.2.6 Configuring the Ethernet Port

You can set the Ethernet parameters via the embedded web pages (requires a network hub or switch connection).

8 Using KDS-17EN Embedded Web Pages

 You can also configure KDS-17EN via Protocol 3000 commands (see [Protocol 3000 Commands](#) on page 84).

If a web page does not update correctly, clear your Web browser's cache.

Some features might not be available in some mobile device operating systems.

For instructions on how to connect the encoder and load the web pages, see [Accessing the Embedded Web Pages](#) on page 20.

8.1 To Browse the KDS-17EN Web Pages

1. Open your Internet browser.
2. Type the IP number of the device in the Address bar of your browser. For example, the default IP number:
The Login window appears.

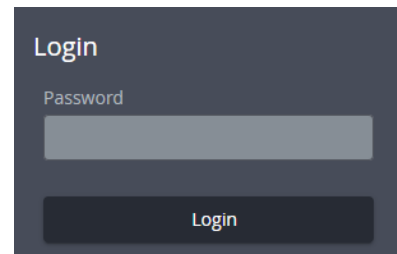

Figure 13: Login Window

3. Enter the Password (admin, by default); The KDS-17EN page appears.

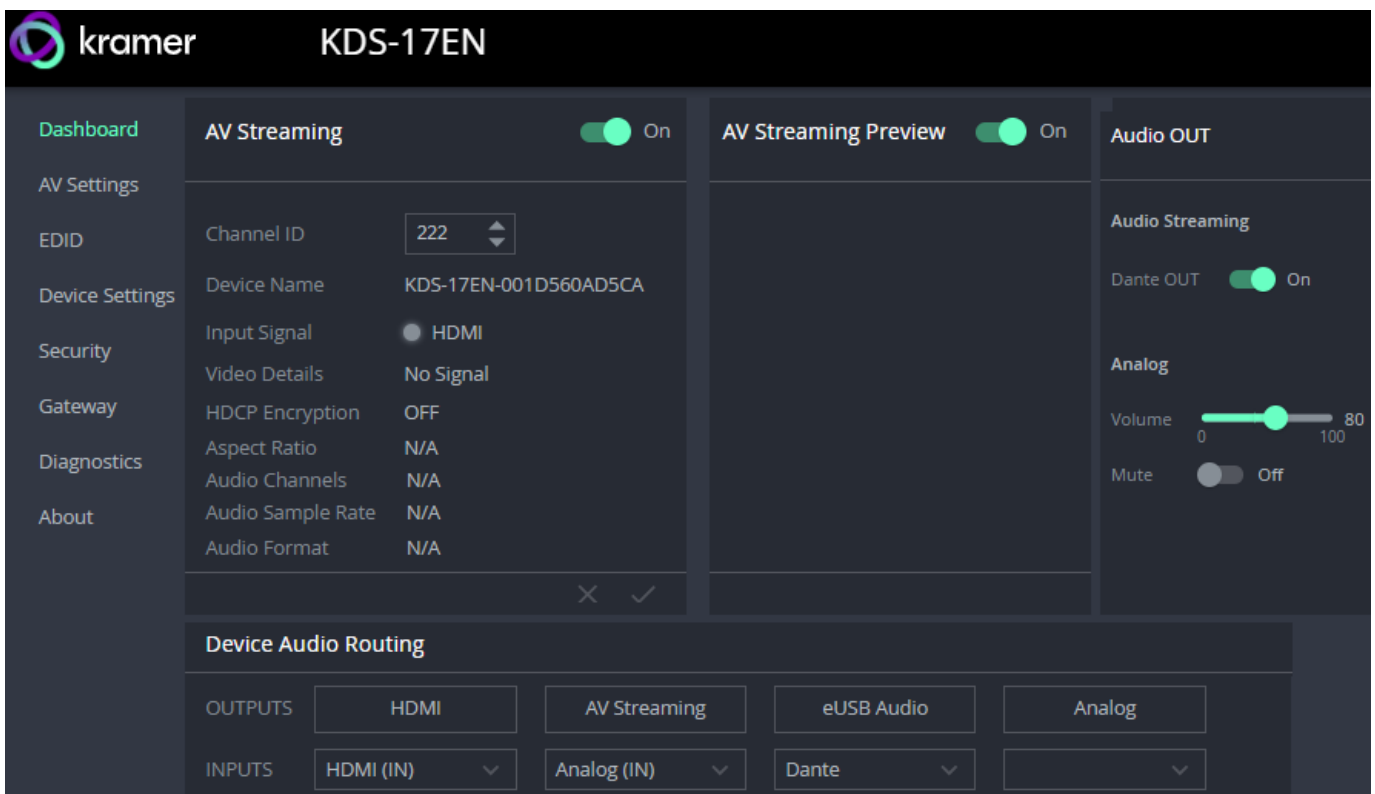

Figure 14: Embedded Web Page with Navigation List on Left

4. Click the tabs on the left side of the screen to access the relevant web page.

8.2 Dashboard: Overview of Streaming

The KDS-17EN Dashboard shows an overview of AV streaming and audio information. Use the dashboard to set the streaming channel, mode and audio parameters.

8.2.1 To set the streaming channel

1. In the **Dashboard** pane, activate **AV Streaming**.
2. Update the **channel ID**:
 - Channel assignation is automatic. To manually set a channel number use the arrows or click on the box (1 - 999). **The same channel ID must be set on the decoder.**

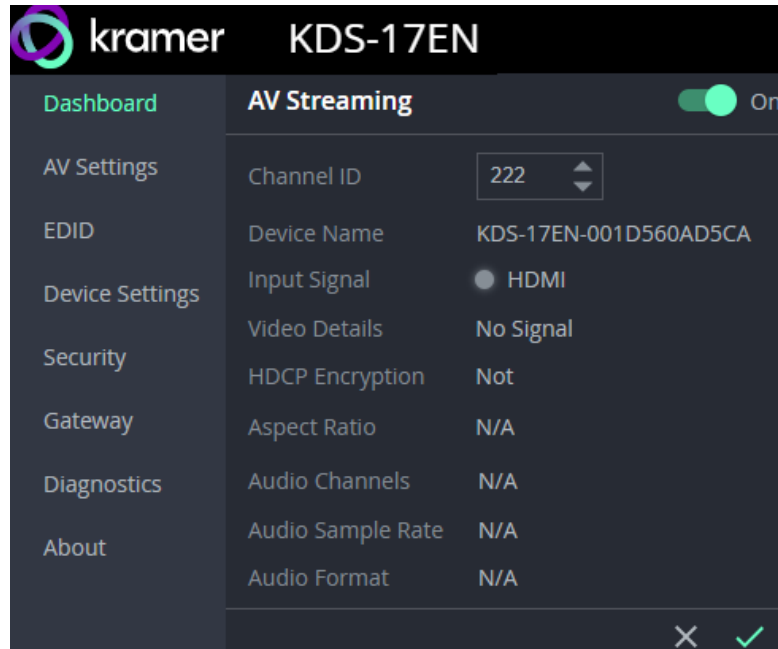

3. Additional non-editable fields are displayed to describe the input AV:
 - **Device Name** – The network host name. Can be updated in **Device > General**.
 - **Input Signal** – Source of the input video.
 - **Video Details** – Input video's resolution.
 - **HDCP Encryption** – Is HDCP active, (High-bandwidth Digital Content Protection) used to protect copyrighted material.
 - **Aspect Ratio** – Aspect ratio of the input video.
 - **Audio Channels** – Number of channels in audio input.
 - **Audio Sample Rate** – Input audio signal's sample frequency (number of samples per second).
 - **Audio Format** – LPCM (uncompressed audio), Dolby (compressed), HBR (compressed high bit rate, such as Dolby TrueHD).
4. Click the green check to confirm any changes.

8.2.2 To preview the AV Stream

In the Dashboard pane, activate **AV Streaming Preview**.

The AV Streaming Preview aspect ratio, FPS and bandwidth can be changed in **AV Settings > Video** (see Preview).



8.2.3 Outputting a Dante stream and/or Analog sound

To output a Dante stream; In the **Dashboard** pane's **Audio OUT** field group, activate **Dante OUT**. By default Dante is activated.

If you are outputting **Analog** audio (this is set in **AV Settings > Audio**), you can set the analog volume or mute the analog sound in this field group. Note that analog can only be input or output: Not both.

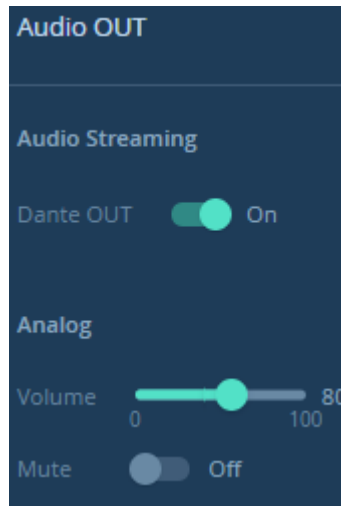

Figure 15: Dashboard: Dante OUT

8.2.4 To set the audio input source and output destination

In the **Dashboard** pane's **Device Audio Routing** field group, select the INPUTS (audio input source) and OUTPUTS (audio output destination).

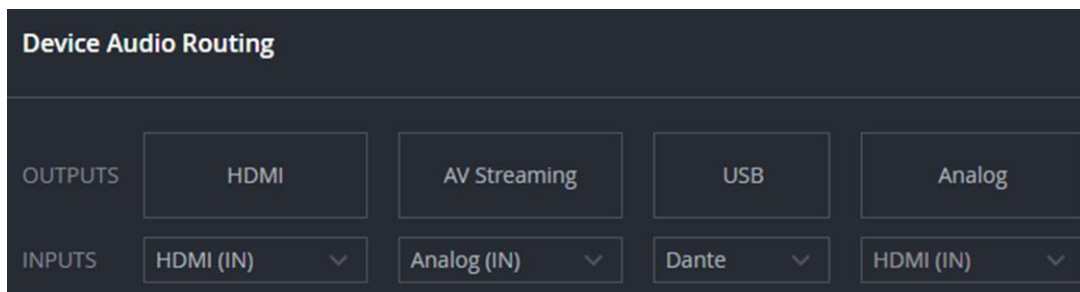

Figure 16: Dashboard: Audio Routing Options

OUTPUTS – Audio Destination

- **HDMI** – The audio loops out of the HDMI OUT port of the KDS-17EN.
- **AV Streaming** - The audio is streamed to the network through the KDS-17EN LAN output. The audio format can be the KDS-17EN Native Audio Stream (connected to the video) and/or a separate Dante Audio Stream (requires Dante input and activation in Audio OUT).
- **USB** – eUSB audio is output to an emulated USB UAC device such as a USB speaker connected to a PC/laptop which is connected to the USB Host port.
- **Analog** – Audio is output to the analog I/O port of the KDS-17EN.
 - The analog audio direction must also be set in **AV Settings > Audio**.
 - The analog audio port can only deliver audio in one direction, not both.

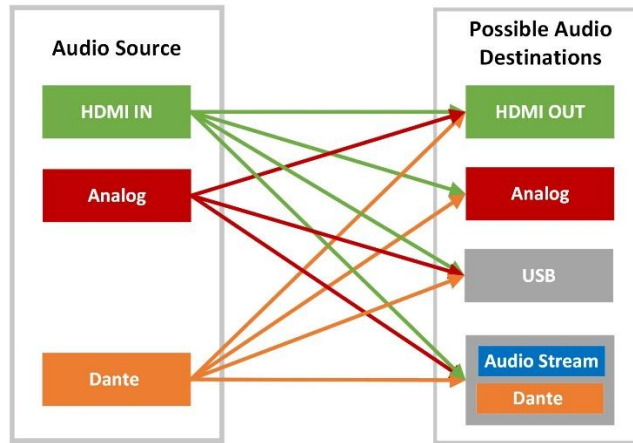

Figure 17: Audio Routing Options

INPUTS – Audio Source

- **HDMI (IN)** – Audio is extracted from the HDMI input on KDS-17EN.
- **Analog (IN)** - Audio is input from the analog I/O port of the KDS-17EN.
 - The analog audio direction must also be set in **AV Settings > Audio**.
 - The analog audio port can only deliver audio in one direction, not both.
- **Dante** - A Dante stream is input from the network via Dante Control. KDS-17EN must be set as a subscriber of this stream in the Dante software. For more information on inputting Dante audio, see [Defining Dante Audio as an Audio Source or Destination](#) on page [77](#).

8.3 AV Settings: Define Video and Audio Output

Define KDS-17EN output AV stream settings. There are two tabs: **Video** and **Audio**.

8.3.1 Video tab: Define video output

1. Select the **AV Settings** pane. The **Video** tab opens.

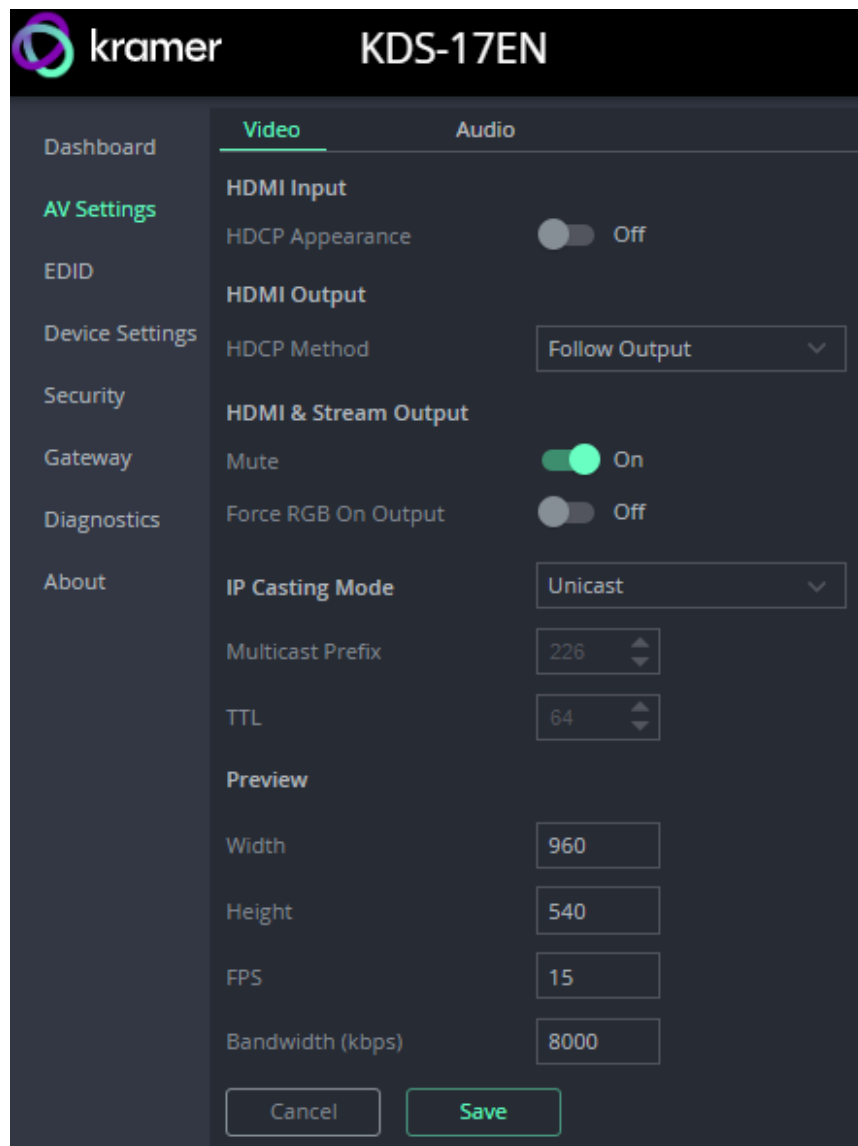

Figure 18: AV Settings – Video tab

2. Define the following settings:
 - **HDMI Input:** Enable (default) / disable HDCP encryption for the HDMI input.
 - **HDMI Output:** Set if HDCP is activated when the input source has HDCP or when the output destination uses HDCP.
 - **HDMI & Stream Output:**
 - **Mute** – Set whether the HDMI and Stream output includes sound.
 - **Force RGB on Output** – Force video output to separate red, green and blue colors. Required by some monitors. Off by default.

- **IP Casting Mode:**
 - Unicast / Multicast (default) – Multicast communication transmits the data stream to multiple receivers simultaneously, select unicast if your stream is intended for a single receiver.
 - Multicast Prefix – Select a prefix for the multicast stream’s IP between 224 and 239 (default prefix is 226.x.x.x). Routers identify multicast streams by their IP prefix and handle the stream’s packets as data which is not directed to a specific recipient: It is a general stream addressed to the entire network.
 - TTL - Time To Live (TTL) restricts the number of times a packet/data can be forwarded by network routers before it is discarded. It stops the stream data from circulating endlessly in the network. Select a value between 1 and 65535.

 - **Preview:** Set the parameters of the Dashboard’s **preview stream**.
 - Width – 1 to 1280 (default 960).
 - Height – 1 to 720 (default 540).
 - FPS- 1 to 60 (default 15).
 - Bandwidth in kbps – 1 to 50,000 (default 8000).
3. Click **SAVE**.

8.3.2 Audio tab: Define Audio Output

Set the source of the encoder audio input and method used to output the audio.

Defining Analog Audio Direction:

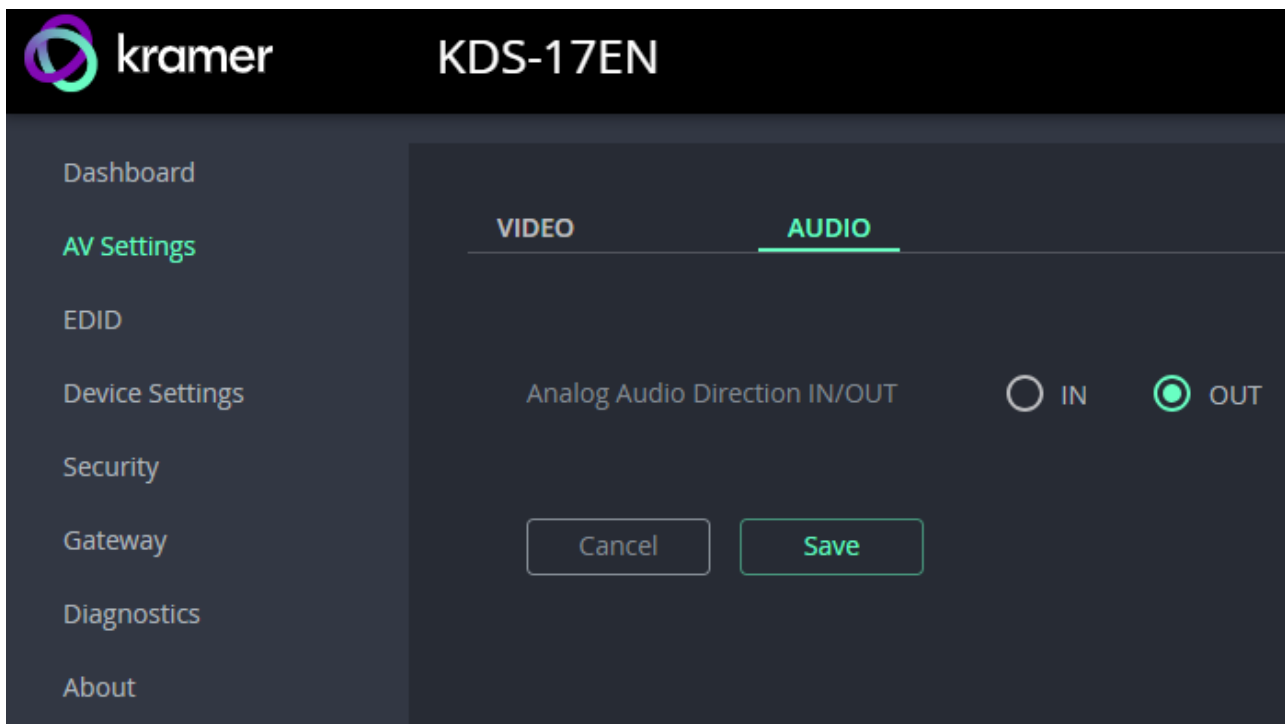

Figure 19: AV Settings > Audio, Analog Audio

- **Analog Audio Direction IN/OUT** - Select IN (default) or OUT. Analog audio uses the encoder's 5-pin terminal block connector (14 in [Defining KDS-17EN](#) on page 6). It can only be in one direction (in or out), which must be specified.

Click **SAVE** after changing settings.

8.4 EDID: Setting Display Metadata

EDIDs (Extended Display Identification Data) are metadata sent from HDMI display devices which describe their formatting and capabilities. The EDID is used to adjust output sent to the display device, so that it matches the display's requirements. **KDS-17EN** can retrieve an EDID from a remote display (connected to the decoder), use the predefined default EDID or upload a custom EDID from a connected computer.

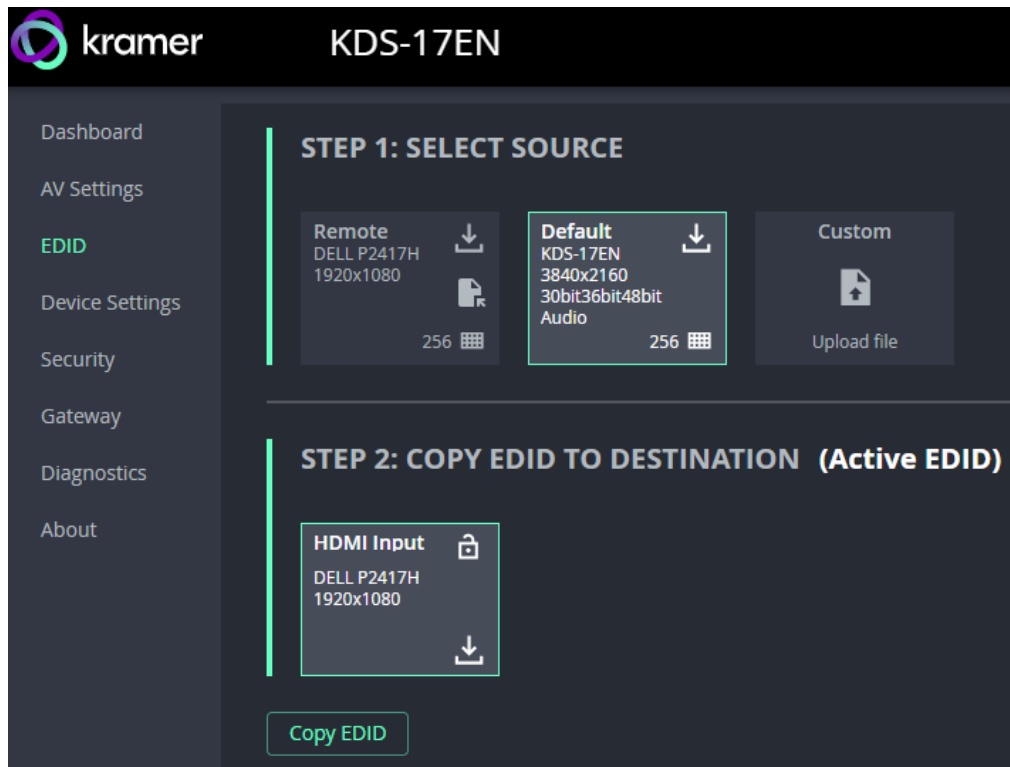

Figure 20: EDID pane

Step 1: Select Source.

To set an EDID, click on a **Select Source** square and then click **COPY EDID** at the bottom; The selected EDID will be copied to **Step 2**.

Click **256** to view the EDID bitmap.

Click the download icon to store the EDID on your computer.

Select Source options:

- **Remote** – Opens a pop-up for entry of the desired decoder's IP address. The EDID of the screen connected to the HDMI Out port of the selected decoder will be returned to the device. Click the download icon to store it on your computer.
- **Default** – A default EDID is supplied with the **KDS-17EN**.
- **Custom** - Upload a stored EDID file from your computer.

Step 2: Copy EDID to Destination

Click **COPY EDID** and your selected EDID will be loaded into Step 2.

EDID is managed.

8.5 Device Settings: General, Network, Time

The KDS-17EN Device pane has three tabs:

- **General** – Sets the KDS-17EN host name, updates firmware, restarts or resets KDS-17EN. You can also export or input KDS-17EN settings.
- **Network** – Set the LAN 1 and LAN 2 parameters for the device.
- **Time & Date** – Define an NTP (network time protocol) server or set the time. An NTP server is advisable, as it coordinates the time between all the connected devices.

8.5.1 General tab

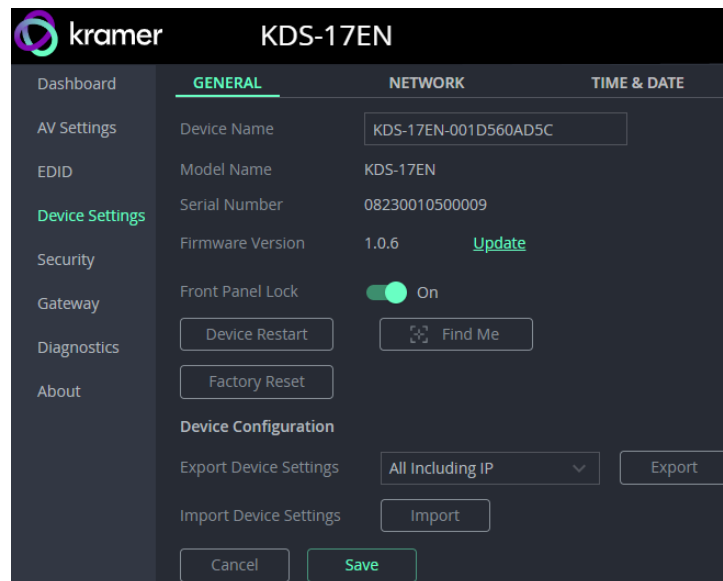

Figure 21: Device Settings – General tab

- **Device name** – Edit or view the device’s Host name (default is <model>-<MAC>).
- **Model Name** of the encoder.
- **Serial Number** of the encoder.
- **Firmware Version** – To update the encoder firmware, download the latest version from <http://www.kramerav.com/downloads/kds-17en> to a local network location and then click **Update** to select and upload it.
- **Front Panel Lock** – Enabling this option prevents use of the LCD Display.
- **Device Restart** – Click to restart KDS-17EN (confirmation will be requested).
- **Factory Reset** - Click to reset the device's operation mode and restart the device (confirmation is requested).
- **Find Me** – The LEDs will flash fast for 60 seconds to identify the device.



When an HDMI OUT screen is connected without input, the screen shows the device’s IP.

- **Device Configuration** –
 - **Export Device Settings** – Outputs a settings file with the name “file.tar.gz”. Settings are stored in JSON format.
 - **Import Device Settings** – Imports a settings file in the same format as the output file (tar.gz). The device will be reset to the uploaded settings.

Click **Save** to store changes or update settings.

8.5.2 Network tab: Using LAN 1 and LAN 2 for different streams

KDS-17EN has two Ethernet ports, LAN 1 and LAN 2 (11 and 12 in [Defining KDS-17EN](#) on page 6). By default, all network connections use both ports, however you can separate the types of stream sent to/from each port and use different IP addresses for the each port. For example, use one port for AV and the other for control commands such as P3K (P3000 API) commands.

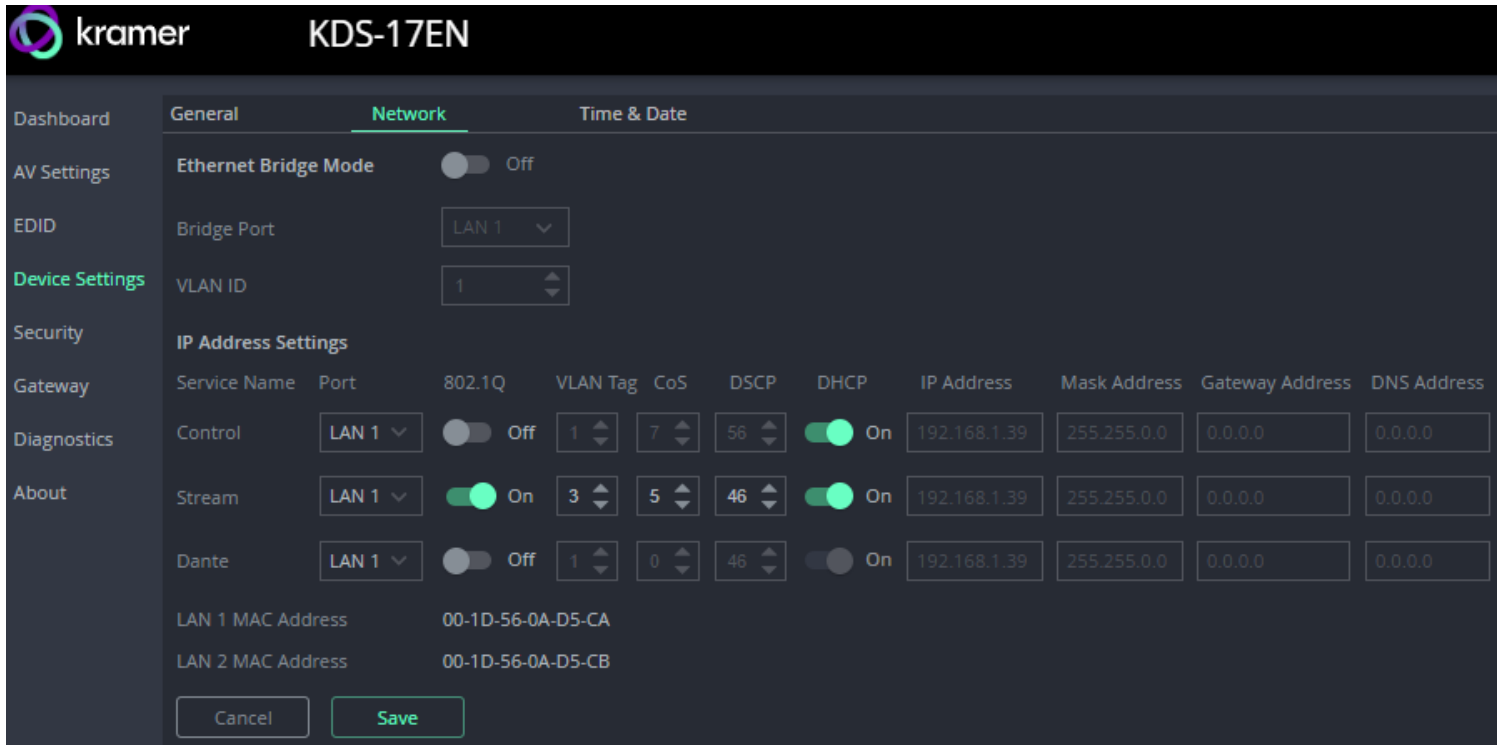

Figure 22: Device Settings pane – Network Tab

Ethernet Bridge Mode – Enable if you want to enable a connected third party device to access the network.

- **Bridge Port** – LAN 1 or LAN 2. When enabled, the port used as a bridge cannot be used for the Control, (AV) Stream or Dante streams
- **VLAN ID** – Ethernet data tagged with the selected VLAN ID will be allowed to reach the bridge port.

IP Address Settings –

- **Service Name** -
 - **Control** is for PK3000 commands, RS-232 and IR data.
 - (AV) **Stream** is for the AV stream.
 - **Dante** (Digital Audio Network Through Ethernet) is for transmitting high-quality digital audio over Ethernet.
- **Port** – LAN 1 or LAN 2. The Ethernet port used by the service.
- **802.1Q** – If set to On (off by default), the data transmission uses VLAN tags.
 - **VLAN Tag** – VLAN (virtual local area network) tags (range 2 – 4000) are used to separate the network into smaller virtual networks. Requires **802.1Q** to be set to On. If Ethernet Bridge Mode is enabled, none of the streams can use its VLAN ID.

- **CoS** – Class of Service, requires a unique VLAN tag. CoS sets the priority (0-7) of each of the VLAN options within the local network (layer 2 of the OSI model). Higher priority traffic is prioritized and provides a more reliable service. If the stream and the control share the same LAN, the control is always CoS 5. Dante always has CoS 0.
- **DSCP** – The DSCP (Differentiated Services Code Point) value is used to mark the priority (0-63) of packets in a WAN network layer (layer 3 of the OSI model). It is used for large-scale networks (or across the Internet) and increases the quality of service. By default DSCP is 56 for the Control stream and 46 for Dante always has a DSCP of 46 (even if 802.1Q is off).
- **DHCP** – If set to On, the service’s IP address is generated automatically. If set Off, you may need to define a static IP address for the service.

To separate Control streams from the AV stream

1. Change the following settings in the **IP Address Settings** section of the **Network** tab (see [Figure 22](#) for more information):
 - In the **Control** row’s **Port** column select **LAN 2** and set **802.1Q** to **On**.
 - In the **VLAN Tag** column, enter an integer number (2 - 4000) for Control services. This separates the Control packets.



802.1Q and VLAN are not required for Dante.

2. To use a static IP for LAN 2, set DHCP to **Off** and enter a subnet mask and gateway address. If no static IP is defined, the DHCP server will allocate the IP.

If no DHCP server exists in the system, the device will look for a random unique IP in the range of 169.254.X.Y. The allocated IP address is shown in the IP address field.

To separate Dante/AES67 Audio from the AV streams:



In this screen, Dante is also used for AES67 streams.

For more information [see Defining Dante Audio as an Audio Source or Destination on page 77](#).

1. To export Dante audio from the encoder, you must first go to the KDS-17EN **Dashboard** pane and set at least one of the **Device Audio Routing** INPUTS to Dante. You must also enable Dante output in the Audio OUT field group.
2. In the KDS-17EN **Device Settings** pane, open the **Network** tab (see [Figure 22](#)):
 In the **IP Address Settings**, set the **Dante** row’s **Port** column to a different value from the (AV) Stream port and set **802.1Q** to **On**.
 In the **VLAN ID** column, enter an integer number (2 - 4093) for Dante services. Make sure this is different from the number used for the Control packets.
3. To use a static IP for the Dante port, set DHCP to **Off** and enter a subnet mask and gateway address. If no static IP is defined, the DHCP server will allocate the IP.

Dante audio output is now defined.

8.5.3 Time & Date tab

To sync device time and date from a network time server:

1. In the **Device** pane, select the **Time & Date** tab. If no NTP Time Server is defined, the time will be set to 1970 every time the device reboots.
2. Set the **Time zone**.
3. Set **Use Time Server (NTP)**, to On.
4. Enter the **Time Server Address** IP.
5. Click the green arrows  to check that the server is available.
6. Click **SAVE**.

The devices date and time are synchronized to the server address entered.

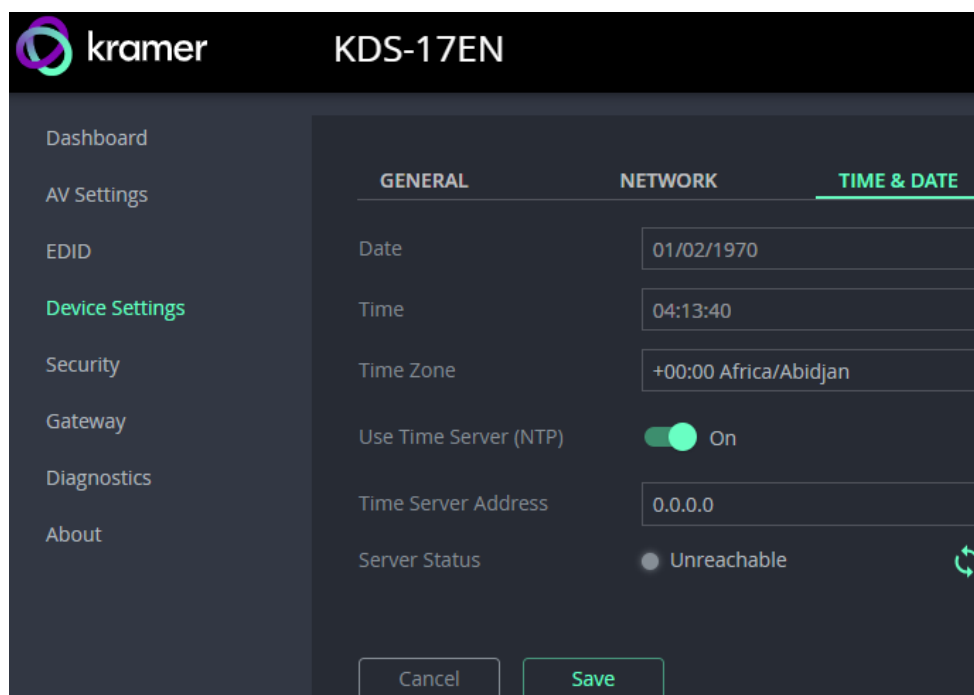



Figure 23: Device Settings – Time & Date

8.6 Security: Passwords, HTTPS, 802.1X and AES256

 Password protection of the web pages is only active when the **Security Status** is On (the default state). The default password is “admin”.

If you change the password, the new password must include a number, a special character and both upper and lower-case letters (no commas or spaces).

The KDS-17EN **Security** pane has three tabs:

- **Device Security** – Enable/disable security and change the device password.
- **HTTPS** – Use the device’s internal certificate or upload a local certificate.
- **802.1X**- Enable and setup IEEE 802.1X authentication.
- **AES256** – Set the level of AES256 encryption.

8.6.1 Device Security tab: Enable Password Control

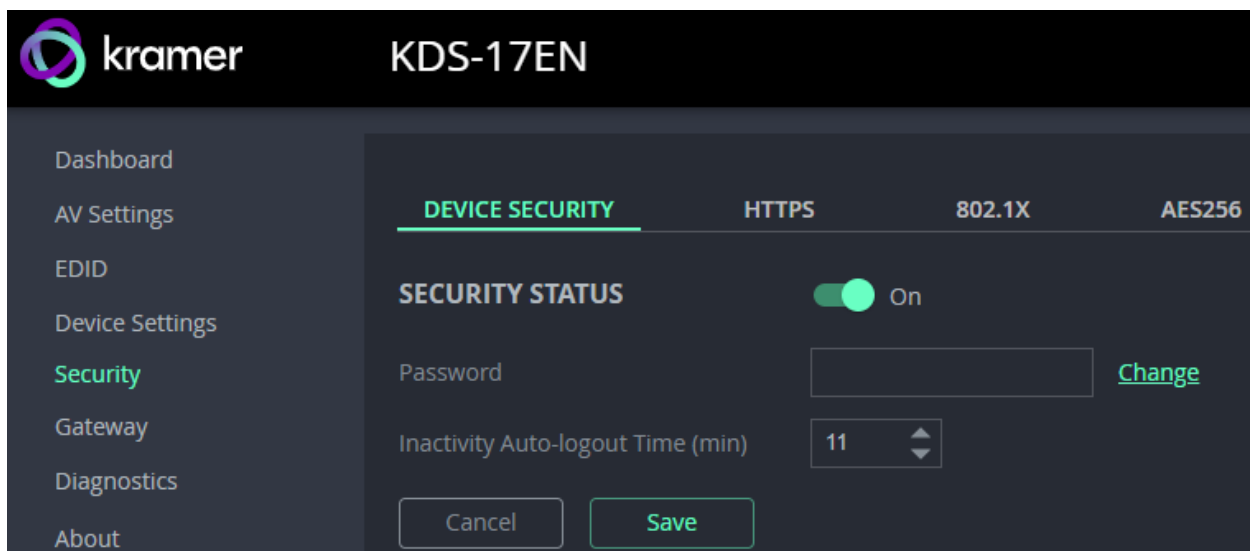

Figure 24: Security pane – Device Security tab

To change Security Status

Move the slider to enable/disable security.

When security is enabled, access to the web pages requires entry of a password. Changes to the security status require entry of the device’s current password (default: “admin”).

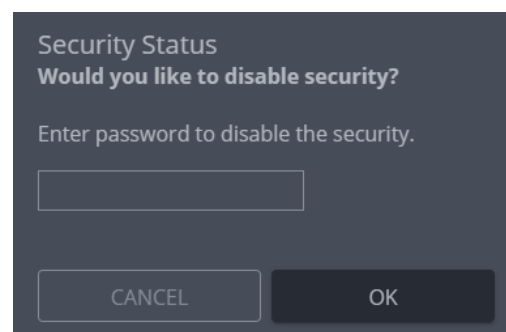
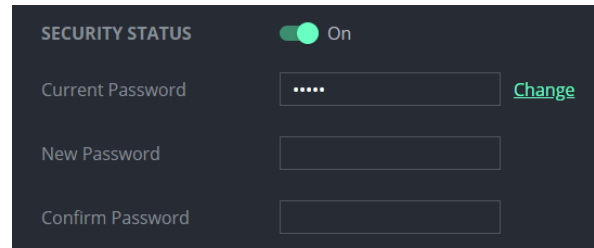

Figure 25: Security pane – pop-up

To change the password

Password protection is only available if the **Security Status** is On. To change the password, enter the **Current Password** and then click **Change**.

The new password must include a number, a special character and both upper and lower case letters (no commas or spaces).



The screenshot shows a dark-themed interface for the Security Status. At the top, 'SECURITY STATUS' is followed by a green toggle switch labeled 'On'. Below this are three input fields: 'Current Password' (containing six dots), 'New Password', and 'Confirm Password'. A green 'Change' button is positioned to the right of the 'Current Password' field.

Figure 26: Security pane – Change password

8.6.2 HTTPS tab

To configure HTTPS:

1. In the **Security** pane's **Device Security** tab, **Security Status** must be enabled.
2. Select the **HTTPS** tab.
3. Select one of the following authentication methods:
 - **Internal Certificate** – Use the factory default certificate for authentication.
 - **Server Certificate** – Upload an authentication certificate from the server (assigned by your network administrator). Click  to upload the certificate. Enter the private key password.

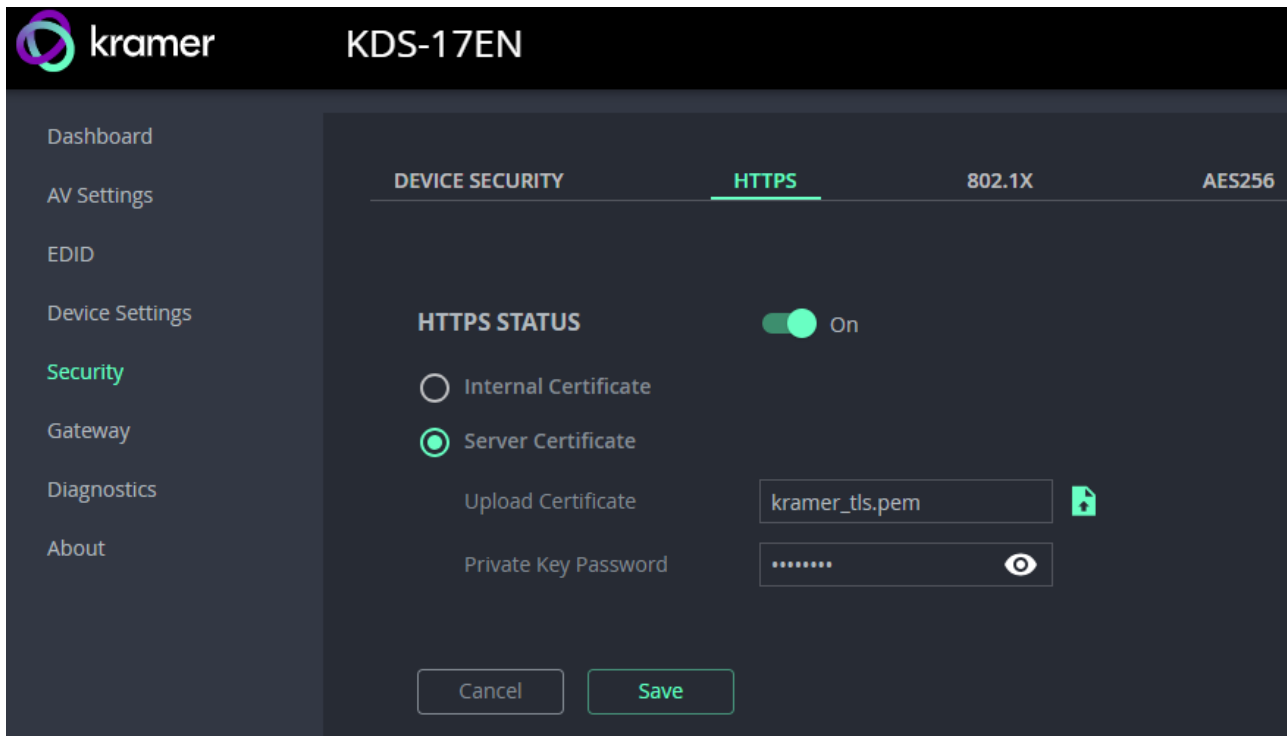

The screenshot shows the Kramer KDS-17EN web interface. The left sidebar contains navigation options: Dashboard, AV Settings, EDID, Device Settings, Security (highlighted), Gateway, Diagnostics, and About. The main content area is titled 'DEVICE SECURITY' and has three tabs: 'DEVICE SECURITY', 'HTTPS' (selected), '802.1X', and 'AES256'. Under the 'HTTPS' tab, 'HTTPS STATUS' is shown as 'On' with a green toggle. Below this are two radio buttons: 'Internal Certificate' (unselected) and 'Server Certificate' (selected). The 'Server Certificate' section includes an 'Upload Certificate' field with the text 'kramer_tls.pem' and an upload icon, and a 'Private Key Password' field with six dots and a visibility icon. At the bottom are 'Cancel' and 'Save' buttons.

Figure 27: Security Tab – Server Certificate

4. Click **SAVE**.

HTTPS is configured.

8.6.3 802.1X tab

802.1X authentication must be defined separately for LAN 1 and LAN 2. 802.1X is a port-based authentication protocol, that uses a RADIUS network access server to authenticate devices accessing the network. It must be configured separately for LAN 1 and LAN 2.

To configure IEEE 802.1X Authentication:

1. In the **Security** pane, select the **802.1X** tab.



LAN 1 / LAN 2 - LAN 2 has identical settings and is at the bottom of the screen. Enable and configure LAN 1 and LAN 2 separately.

2. Set 802.1x authentication **ON**.

3. **Authentication Status:**

- Green – LAN is using 802.1X and authentication has succeeded.
- Orange – LAN is using 802.1X and authentication is in process.
- Red – LAN is using 802.1X but authentication has failed.
- Grey – 802.1X is disabled.

4. Check one of the following settings:

- **EAP-MSCHAP V2** – To use this authentication method, enter the **KDS-17EN** KDS-17DEC username and password.
 - **EAP-TLS** – Submit a certificate from your network authentication server: Enter the **KDS-17EN** Username (“admin”) and click  to upload the Client Certificate and Private Key. Enter the Private Key Password (assigned by network administrator).
5. **Server Certificate** – (optional) Use a CA (certification authority) issued certificate to authenticate the RADIUS server. Enable and click  to upload the CA certificate.

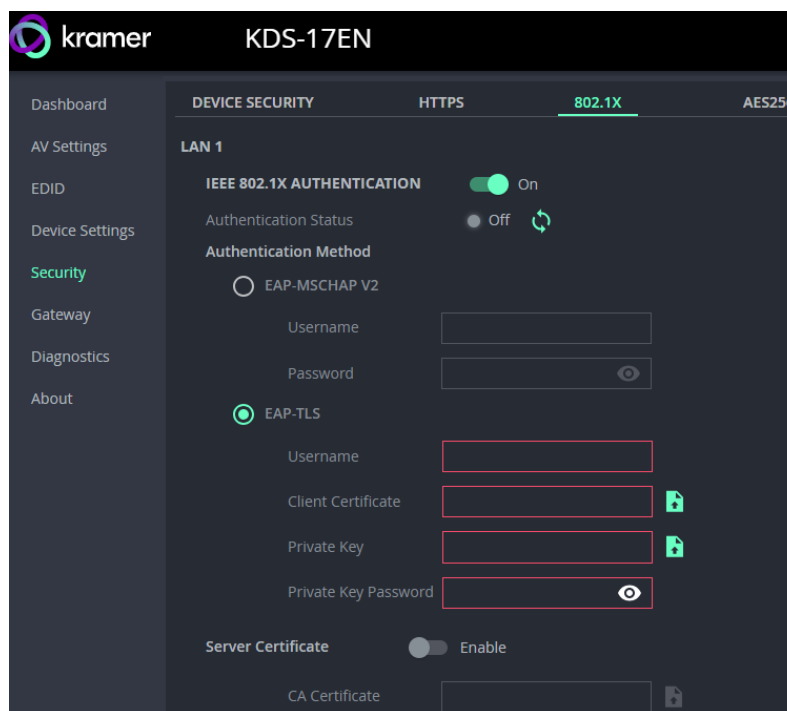

Figure 28: EAP-TLS – Certificates and Password

6. Repeat for LAN 2 if necessary.
7. Click **SAVE**: 802.1X is configured.

8.6.4 AES256 tab

When Device Security is enabled, AES256 encryption is used to encrypt packet headers, Use AES256 Full to encrypt the whole packet. By default, a system key is used for encryption and decryption. If you want to enter a custom key, key make sure both encoder and decoders are updated to use the same key.

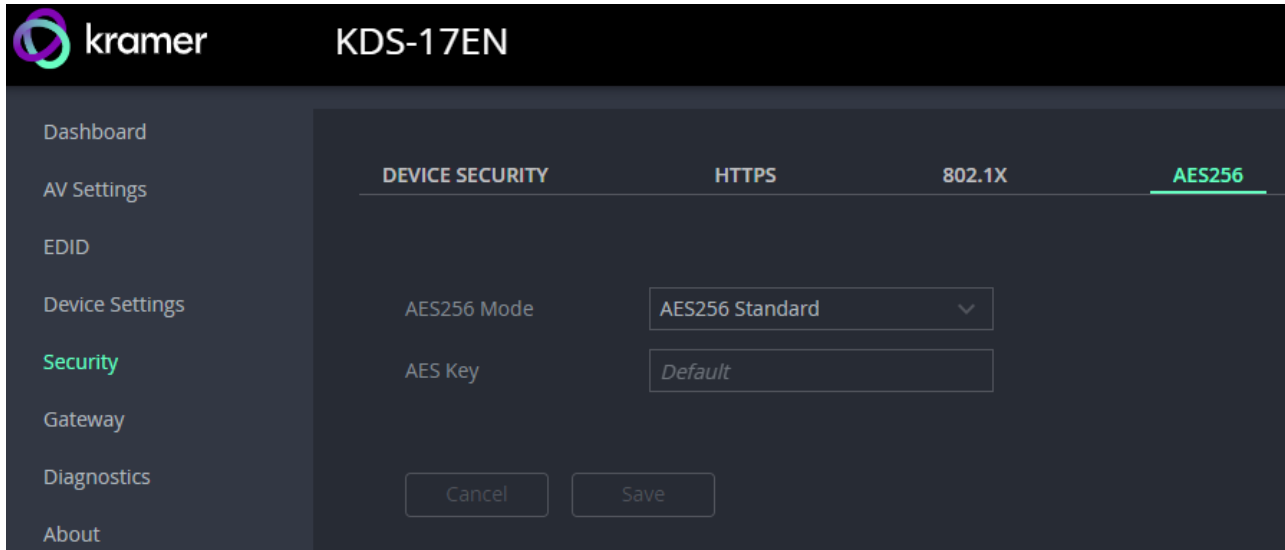

Figure 29: Security pane – AES256 tab

AES256 Mode: Standard or Full.

- **Standard** encrypts the packet headers into blocks of 128 bits each.
- **Full** encrypts the entire packet and requires that Jumbo Frames are enabled on the switch, so that the transmitted IP packet is not larger than the maximum Ethernet frame.

AES KEY: Default or customized.

- **Default** uses 14 rounds of processing to create a device defined 256-bit key.
- **Customized** requires you to enter a 32-byte hexadecimal string (64 characters using only the characters 0 – 9 and A to F). No hex code identifier is required before the string.

8.7 Gateway: CEC, RS-232 and IR definitions

The KDS-17EN **Gateway** pane has three tabs:

- **CEC** – Enable and setup direction of CEC commands.
- **RS-232** – Enable and configure the use of RS-232 communication.
- **IR**- Setup direction of pass-through IR (infrared) controls.

8.7.1 CEC tab: Configuring CEC commands

CEC (Consumer Electronics Control) are commands that HDMI devices can send to connected devices, so that controls sent to a single device are used to control multiple connected devices.

KDS-17EN can send CEC commands over LAN to CEC enabled devices that are connected to the **KDS-17DEC**.

To set **CEC Gateway**:

1. In the Gateway pane, click **CEC**.

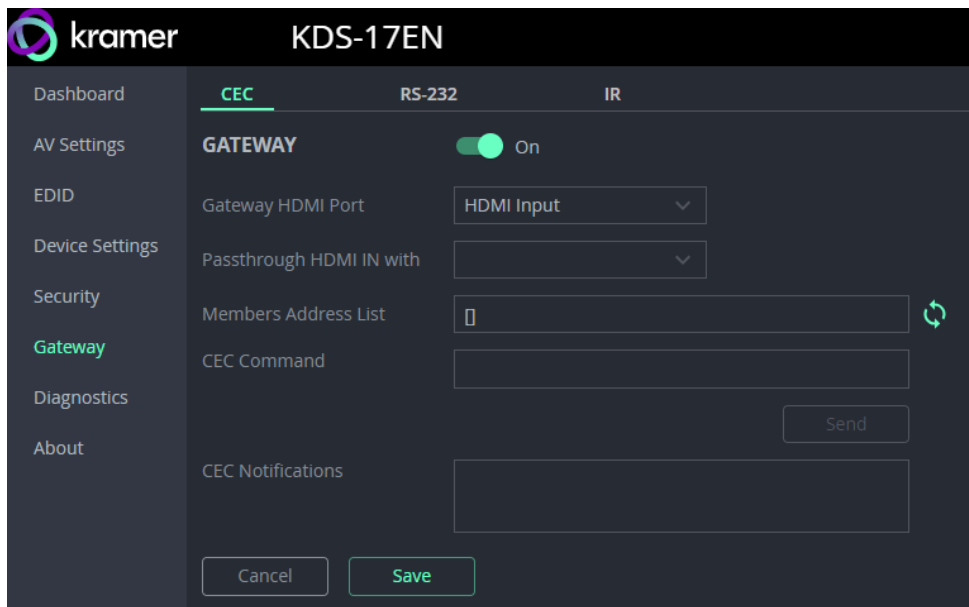



Figure 30: Control > Settings Page – CEC Settings

2. **Enable** the CEC gateway.
3. Select the Gateway HDMI port to which CEC commands are sent (HDMI input or HDMI output).
4. If you are sending CEC commands to the decoder, set **Passthrough HDMI IN with** to **Decoder HDMI Output**.
5. Click refresh , to see the address of the CEC device attached to the HDMI port.
6. Enter the CEC command in hexadecimal format.
7. Click **SEND**.
8. View the CEC-enabled device response in the **CEC Notifications** field.

8.7.2 RS-232 tab

KDS-17EN can receive RS-232 commands over LAN, that were sent to a connected decoder's RS-232 port. These commands can be used to remotely control **KDS-17EN**.

To set RS-232 Gateway:

1. In the Gateway pane, click the **RS-232 tab**.

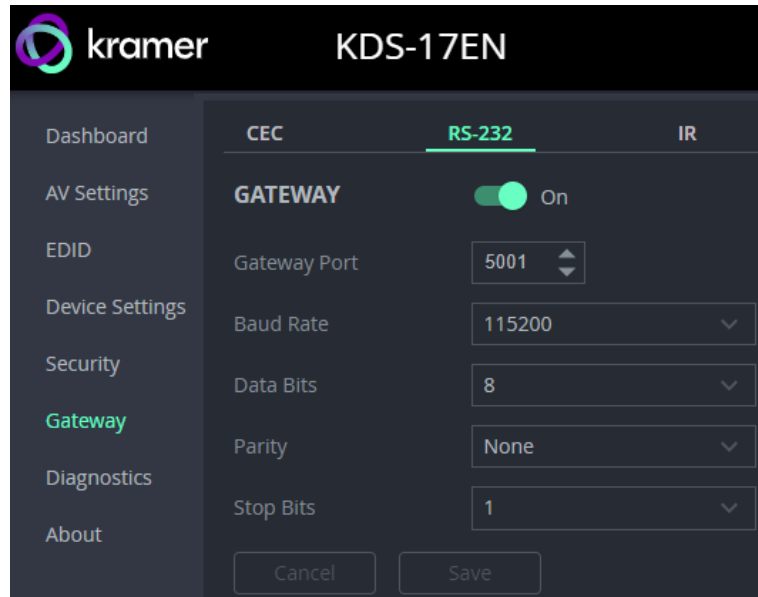

Figure 31: Gateway > RS-232

2. Click **Enable** to enable RS-232 gateway or click **Disable**.
3. Define the RS-232 gateway port (5001, by default).
4. Enter the Baud Rate: 1200 to 115200 (default).
5. Enter the Data Bits: 5, 6, 7 or 8 (default).
6. Enter Parity: None (default), Odd or Even.
7. Enter Stop Bits: 1 (default) or 2.
8. Click **SAVE**.

RS-232 Gateway is configured.

8.7.3 IR tab

KDS-17EN can send or receive IR commands over LAN, to or from a connected decoder. The IR signals can be used to control a relevant device and the direction should be the opposite of that specified on the connected decoder.

To set **RS-232 Gateway**:

1. In the Gateway pane, select the **IR** tab.

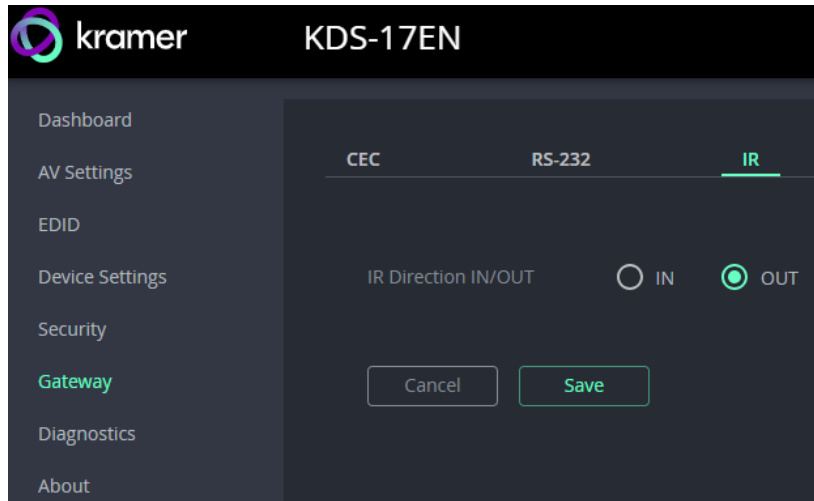

Figure 32: Control > Settings Page – IR Settings

2. Set IR direction:
 - **IN** – Configure the IR port as an input port that is connected to an IR receiver cable.
 - **OUT** – Configure the IR port as an output port that is connected to an IR emitter cable.
3. Click **Save**.

IR Gateway is configured.

8.8 Diagnostics: Status and Connections

The KDS-17EN **Diagnostics** pane has two tabs:

- **STATUS** – View the device’s activity state, temperature, and output ports.
- **CONNECTION** – View the device’s active network connections.

8.8.1 Status tab

1. In the Diagnostics pane, click **Status**.

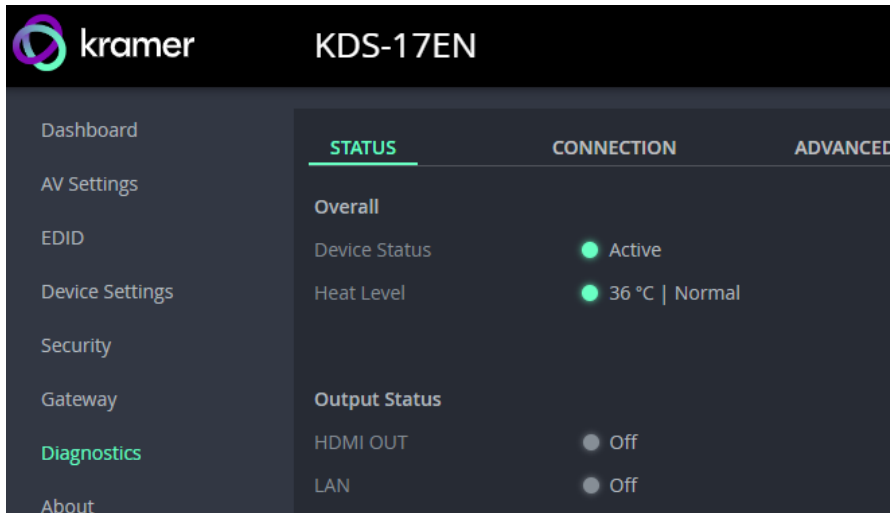

Figure 33: Diagnostics – Status Tab

2. Device Status:
 - **Active**, for normal operation (green indication).
 - **Standby**, when device is powered off, booting or in standby mode.
3. Heat Level:
 - **Normal**, for temperatures below 45°C.
 - **High**, for temperatures between 45°C and 60°C.
 - **Overheat**, for temperatures above 60°C.
4. View the status of the outputs:
 - **HDMI OUT** - On, the output channel is transmitting an active signal.
 - **LAN** – On, a signal is being transmitted.

Device status is viewed.

8.8.2 Connection tab

View the network devices connected to **KDS-17EN**.

To view Connections status:

1. In the Diagnostics pane, click **Connection**.
2. Select the Connections tab.

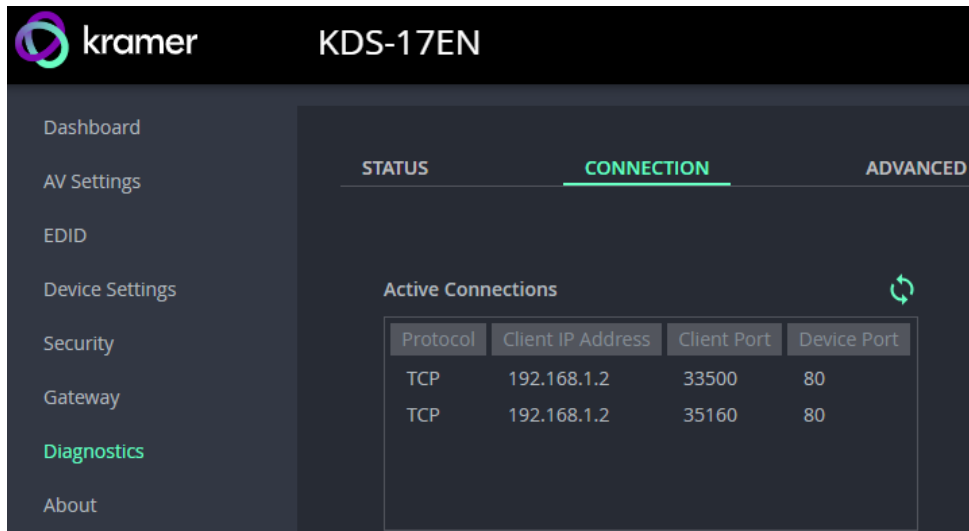

Figure 34: Diagnostics – Connection Tab

3. UCP devices that end the connection will be displayed for 10 minutes after the connection ends.

Connections' status is viewed.

8.9 About

View the device model, hardware release, firmware version and Kramer Electronics Ltd details.

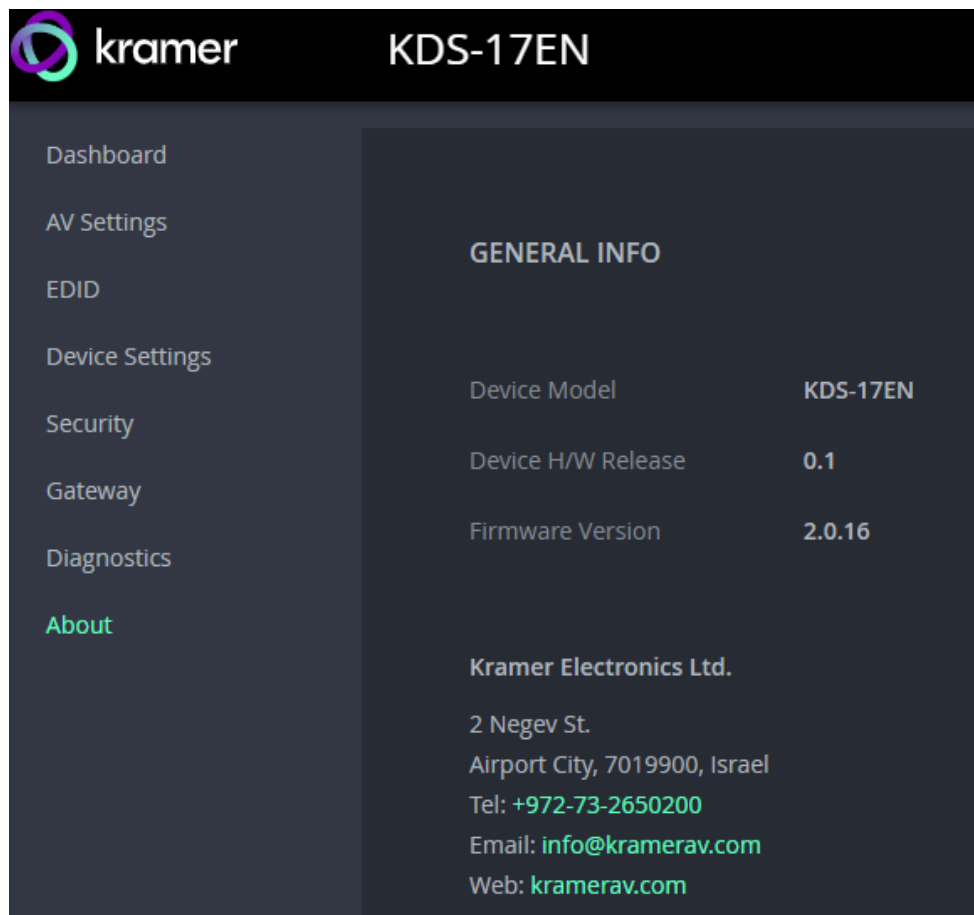

kramer KDS-17EN

- Dashboard
- AV Settings
- EDID
- Device Settings
- Security
- Gateway
- Diagnostics
- About**

GENERAL INFO

Device Model	KDS-17EN
Device H/W Release	0.1
Firmware Version	2.0.16

Kramer Electronics Ltd.
2 Negev St.
Airport City, 7019900, Israel
Tel: [+972-73-2650200](tel:+972-73-2650200)
Email: info@kramerav.com
Web: kramerav.com

Figure 35: About Page

8.10 Upgrading Firmware

Upgrade the firmware, view the date of the last upgrade, or rollback to the previous firmware revision in case of a problem.



Click **ROLLBACK** to update to the previous FW version.



If the device firmware version is lower than 0.6.3, contact Kramer tech support team at support@kramerav.com or go to our Web site at <http://www.kramerav.com/downloads/KDS-17EN>

To upgrade the firmware:

1. In the Navigation pane, Select **Device Settings**. The General tab in the Device Settings page appears.

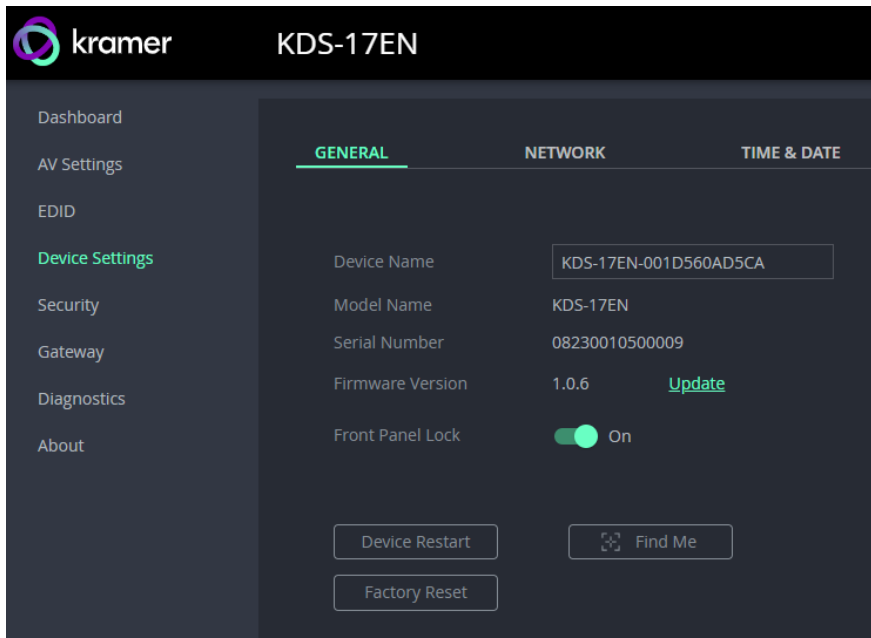



Figure 36: General Tab – Upgrading the Firmware

2. Next to Firmware Version, click **Update**. The Open window appears.
3. Select the FW file and click **Open**. The FW upgrade pop-up window appears. Wait for upgrade completion.
4. Once completed, refresh the web page and log-in.
Firmware upgrade is complete.

9 Using KDS-17DEC Embedded Web Pages

 You can also configure KDS-17DEC via Protocol 3000 commands (see [Protocol 3000 Commands](#) on page 84).

If a web page does not update correctly, clear your Web browser's cache.

Some features might not be available in some mobile device operating systems.

For instructions on how to connect to the encoder and load the web pages, see [Accessing the Embedded Web Pages](#) on page 20.

9.1 To Browse the KDS-17DEC Web Pages

1. Open your Internet browser.
2. Type the IP number of the device in the Address bar of your browser. For example, the default IP number:
If Device Security is enabled, the Login window appears.

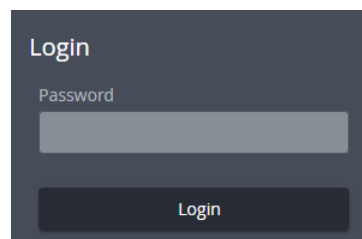
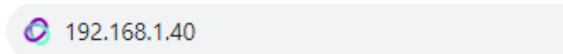

Figure 37: Login Window

3. If required, enter the login password ("admin", by default); The KDS-17DEC Dashboard opens.

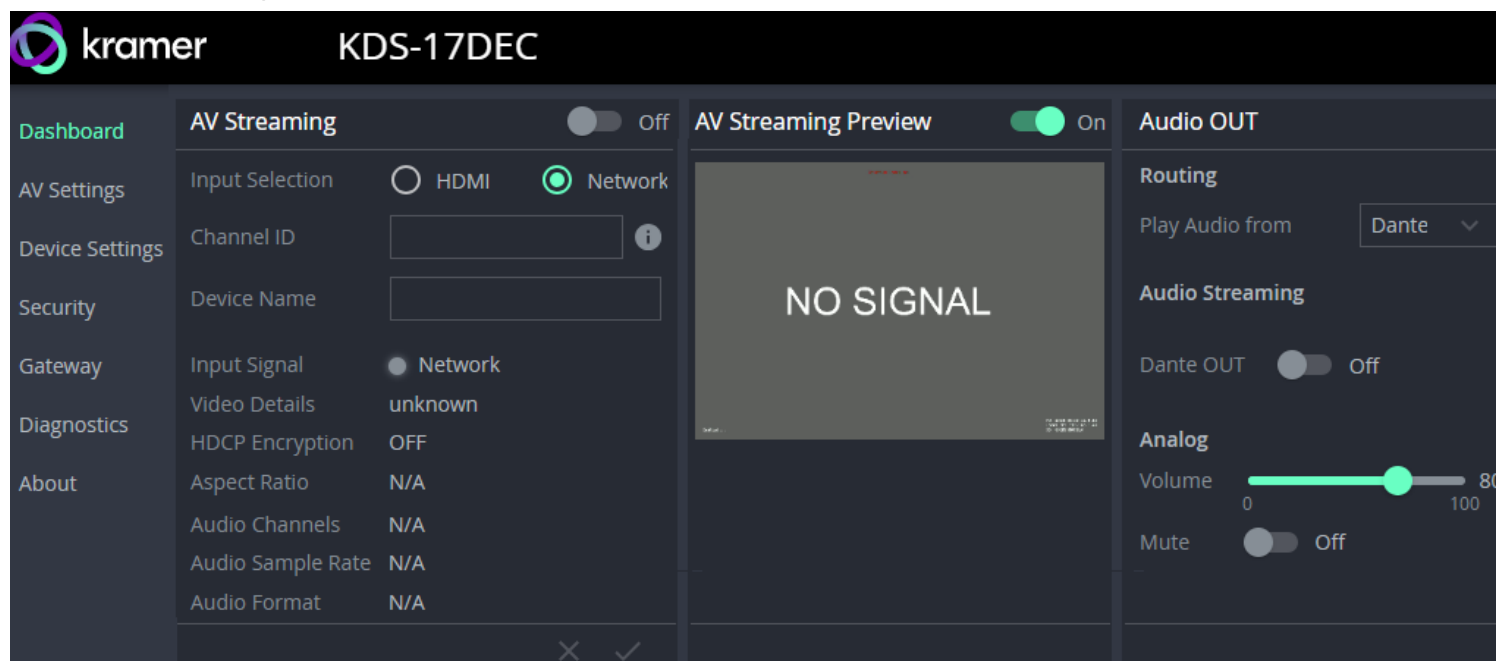

Figure 38: Embedded Web Page with Navigation List on Left

4. Click the tabs on the left side of the screen to access the relevant web page.

9.2 Dashboard: Overview of Streaming

The KDS-17DEC Dashboard shows an overview of AV streaming and audio information. Use the dashboard to set the streaming channel, input source and audio parameters.

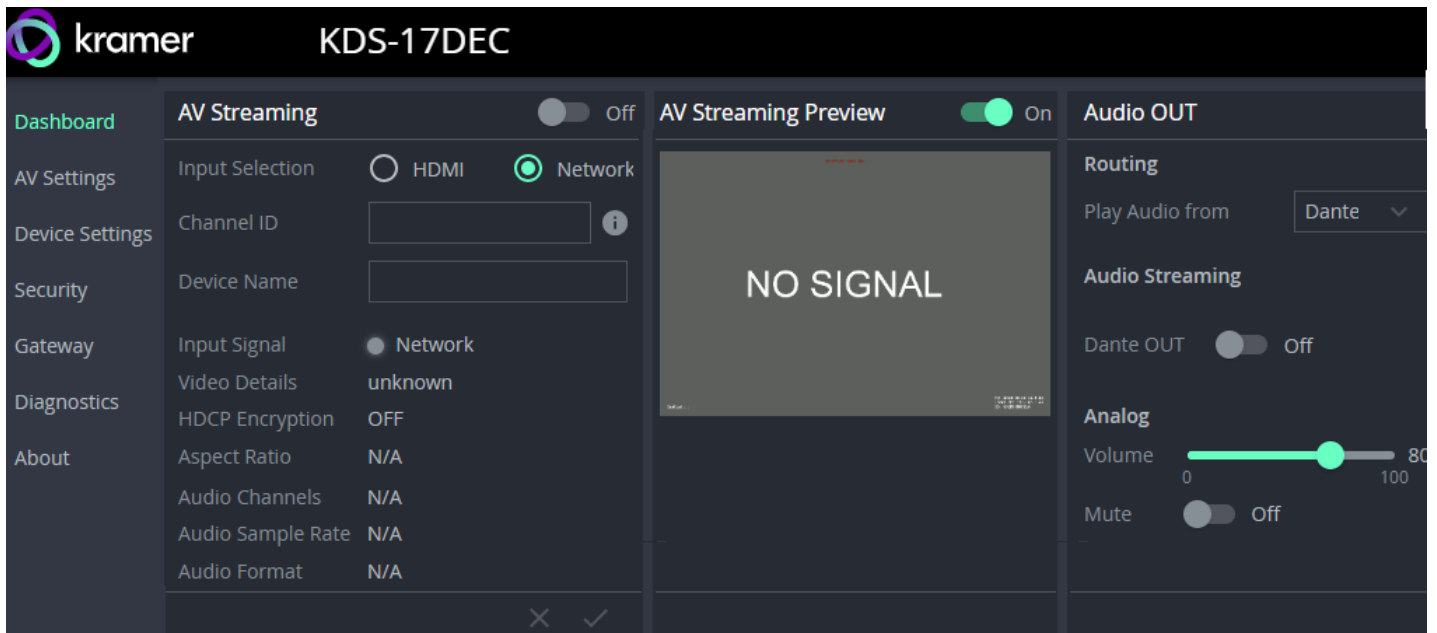

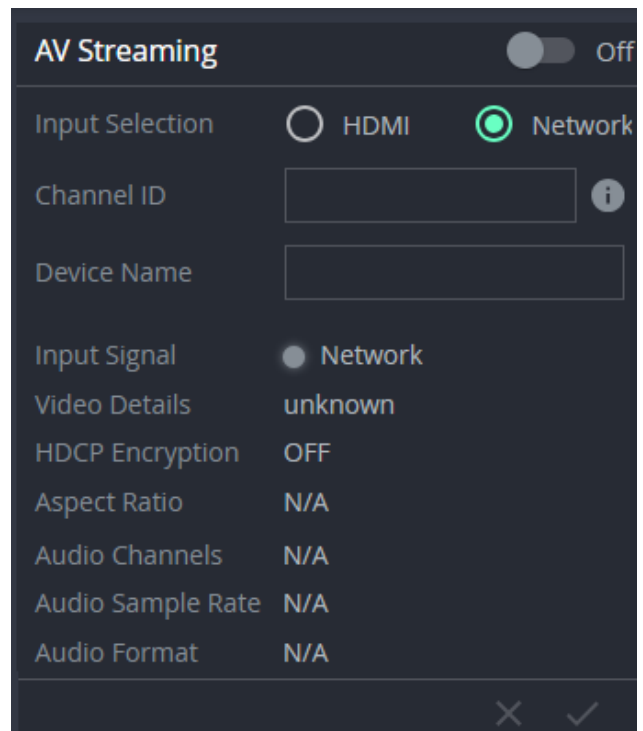

Figure 39: KDS-DEC Dashboard pane

9.2.1 AV Streaming: Set the streaming channel

1. In the **Dashboard** pane, activate AV Streaming.
 2. **Input Selection** – Chose between Network(default) and HDMI.
 3. **Channel ID** - If the input is network, the **Channel ID** must be identical to the channel entered on the encoder. Click the Refresh arrows  and the device will automatically detect the stream and enter its channel ID.
 4. **Device Name** – Select the name of the encoder from the dropdown list.
 5. Additional non-editable fields are displayed to describe the input AV:
 - **Input Signal** – Source of the input video.
 - **Video Details** – Input video's resolution.
 - **HDCP Encryption** – HDCP status (High-bandwidth Digital Content Protection, used to protect copyrighted material).
 - **Aspect Ratio** – The input video signal's aspect ratio, such as 16:9, 4:3 etc.
 - **Audio Channels** – Number of channels in audio input.
 - **Audio Sample Rate** – Input audio signal's sample frequency (number of samples per second).
 - **Audio Format** – LPCM is uncompressed, other types of digital format are usually compressed.
5. Click the green check  to confirm your changes (greyed out if no change is made).



AV Streaming Preview:

In the Dashboard pane, activate **AV Streaming Preview** to view a sample of the input stream in this area.

The AV Streaming Preview aspect ratio, FPS and bandwidth can be changed in **AV Settings > Video** (see Preview).



9.2.2 Audio OUT: Set the audio output

1. In the **Dashboard** pane's **Audio Out** field group, choose how KDS-17DEC outputs the audio.
2. If audio input is in Dante format (Digital Audio Network Through Ethernet), set **Routing** to Play Audio from Dante.
3. If audio output is an audio stream in Dante format, set Audio Streaming **Dante OUT** to On.

For more information on Dante audio, see [Defining Dante Audio as an Audio Source or Destination](#) on page [77](#).

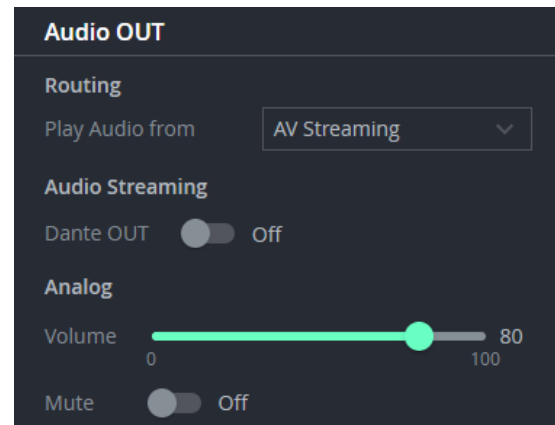

Figure 40: Dashboard: Audio Routing Options

4. If Audio output is Analog (using the AUDIO OUT 5-pin Terminal Block Connector) set the volume slider. Values are in %, maximum output is 12dB. The volume slider only affects the (analog) AUDIO OUT 5-pin Terminal Block Connector (11 in [Defining KDS-17DEC](#) on page [8](#)). Mute affects HDMI Out and Analog out.

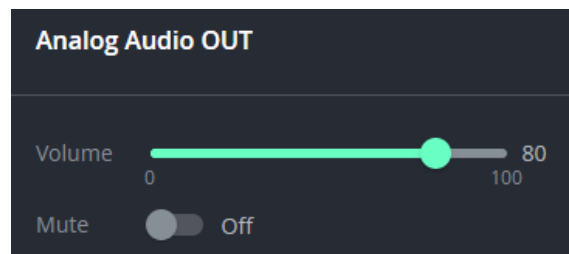

Figure 41: Dashboard: Analog Audio OUT

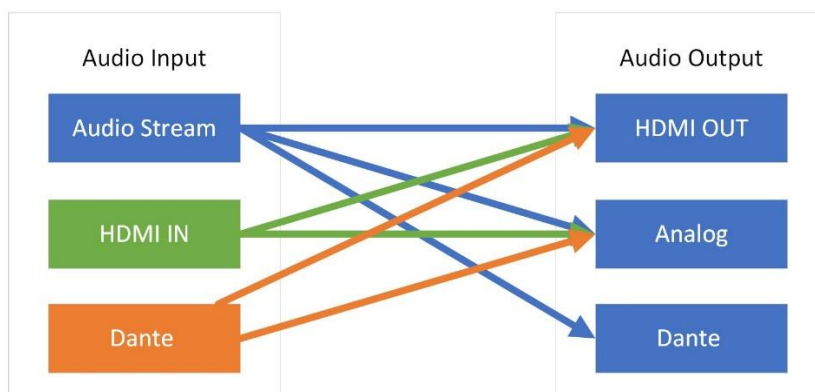
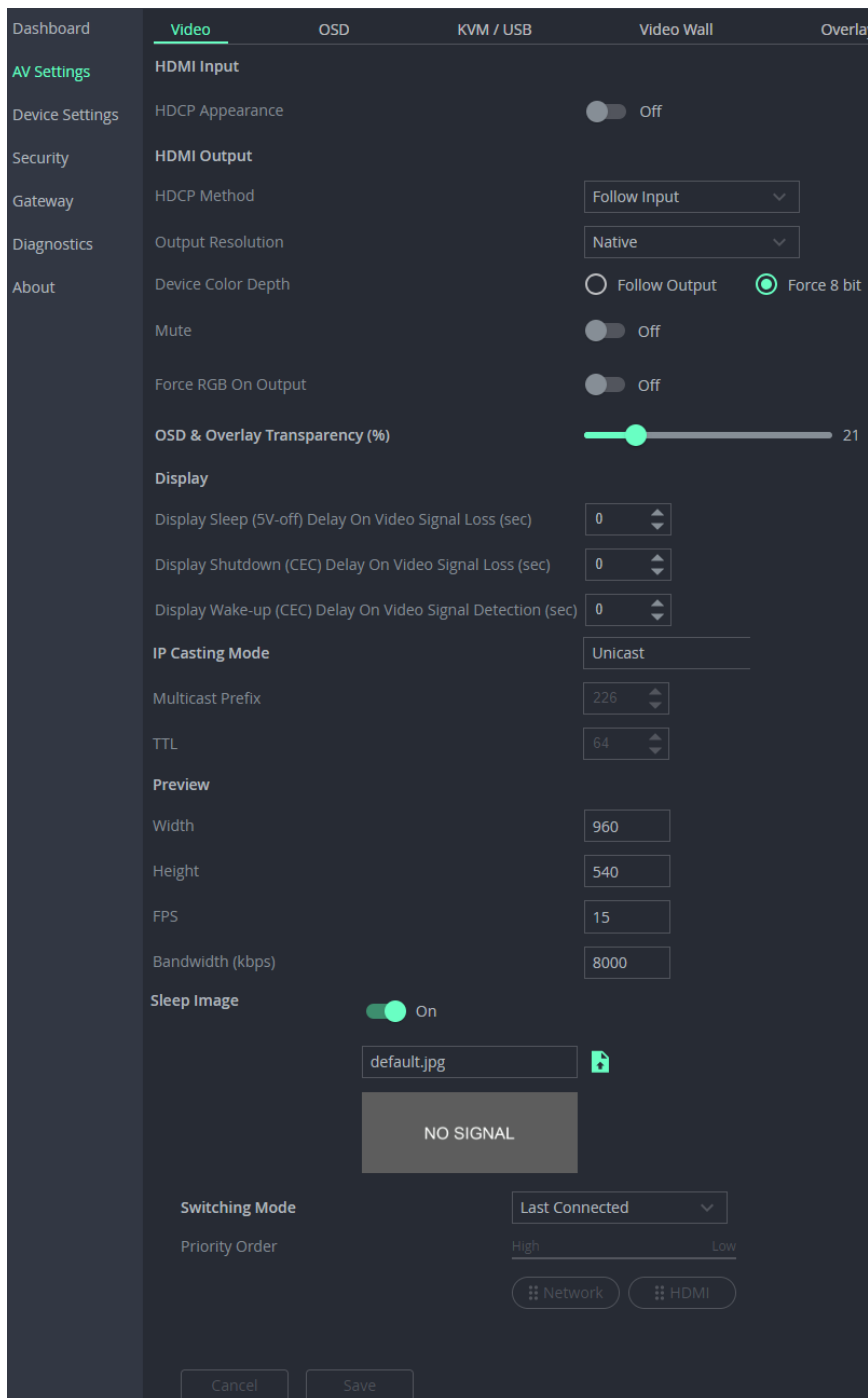

Figure 42: Dashboard: Audio output options

9.3 AV Settings: Video, OSD, KVM, Video Wall & Overlay

Define KDS-17DEC output AV stream settings. There are five tabs:

1. [Video tab](#) (shown below).
2. [OSD tab – On Screen Display menu.](#)
3. [KVM / USB tab – External Keyboard, Video and Monitor.](#)
4. [Video Wall tab – Grid Video Wall / Mosaic Video Wall.](#)
5. [Overlay tab – Overlay an image, text or KVM.](#)



9.3.1 Video tab – Format video output

The Video tab sets 8 features, mostly related to video output. Click **Save** after making changes.

1. HDMI Input

- **HDCP Appearance** – Use this if you are using the decoder’s HDMI IN port and your media source employs HDCP copyright protection. On by default.

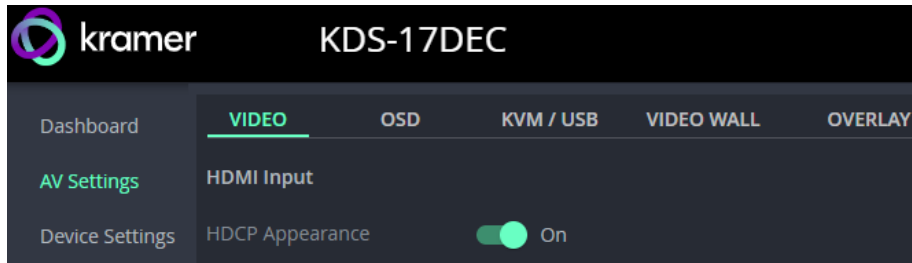

Figure 43: AV Settings > Video – HDMI Input

2. HDMI Output

- **HDCP Method** - Decide how system should handle copyright protection (follow the input stream or follow the destination screen settings).
- **Output Resolution – Native:** Set using the output EDID (see [EDID: Setting Display Metadata](#) on page 31). **Passthrough:** Use the resolution of the input video. Alternatively, select an output resolution from the list.
- **Device color depth** – Follow Output: Set according to the output display. Force 8 bit: Force output into 8-bit format.
- **Mute** – Remove the sound from the HDMI output stream.
- **Force RGB on Output** – Force video output to separate red, green and blue colors. Required by some monitors.

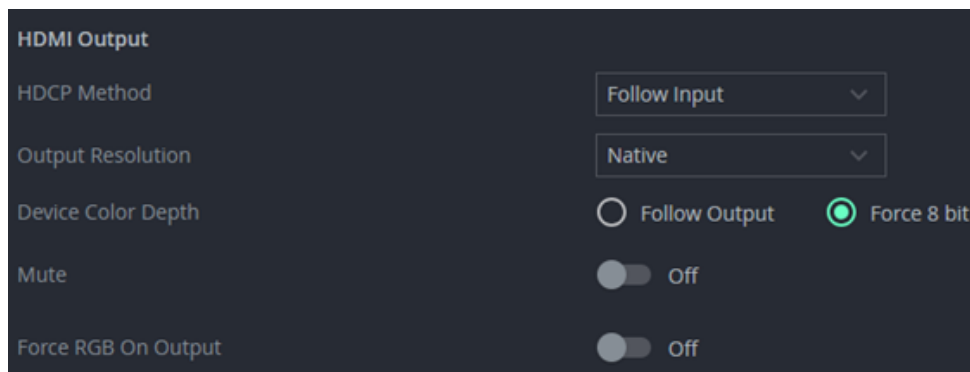

Figure 44: AV Settings > Video – HDMI Output

3. OSD & Overlay Transparency (%)

- Use the slider to set the transparency of the OSD & Overlay texts, KVM Overlay and Overlay image. Default setting: 50%



Figure 45: AV Settings > Video – OSD & Overlay Transparency

4. **Display:** Set the number of seconds the device should wait before sleep / shutdown / Wake-up takes place in the event of video signal loss.

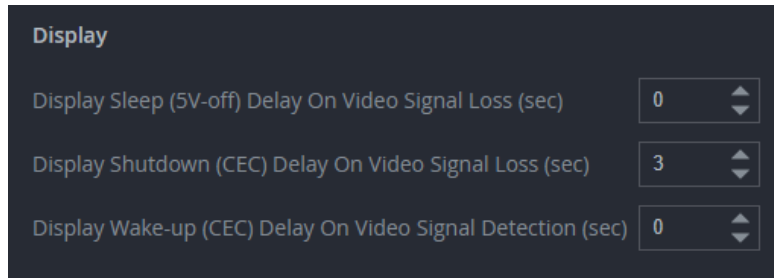

Figure 46: AV Settings > Video – Display (sleep options)

5. IP Casting Mode:

- **Unicast / Multicast** – Multicast communication transmits the data stream to multiple receivers simultaneously, select unicast if your stream is intended for a single receiver.
- **Multicast Prefix** – Select a prefix for the multicast stream’s IP between 224 and 239 (prefix as in 224.x.x.x). IP prefixes are used by routers to identify the stream’s packets as data which is not directed to a specific recipient, but a general stream addressed to the entire network.
- **TTL** - Time To Live (TTL) restricts the number of times a packet/data can be forwarded by network routers before it is discarded. It stops the stream data from circulating endlessly in the network. Select a value between 1 and 65535.



Figure 47: Video - IP Casting Mode

6. **Preview:** Set the parameters of the **Dashboard** stream preview window.

- Width – 1 to 1280 / Height – 1 to 720 / FPS- 1 to 60 / Bandwidth – 1 to 50,000.
Default settings: Width 960, Height 540 and FPS 15.

7. **Sleep Image:** Enable and upload an image to display when the output “sleeps”. On by default (will display “No source” message if no image is uploaded).

8. **Switching Mode:** Set the handling of video inputs. Video can arrive from the HDMI IN port (locally) or from the stream (remotely from the encoder). Options:

- **Manual** – Only output video to the current active output connection.
- **Last Connected** – Only output video to the last used output connection.
- **Priority** - Dynamically switch according to the defined priority (manually drag the sources to set the priority). If no audio input is detected on the top priority, the system will switch to the next priority.
Before switching, the device waits for an audio signal to be detected. The amount of time it waits is set in the signal loss/detection and cable plug/unplug

parameters (to allow time to detect video input).



Figure 48: Video output switching mode

9. Click **SAVE**.

9.3.2 OSD tab – On Screen Display menu

The OSD menu displays an insert on the output display with a list of the encoders streaming channels to **KDS-17DEC**. Users can select a channel from the on-screen menu.

Note: OSD menu transparency is set in the Video tab.

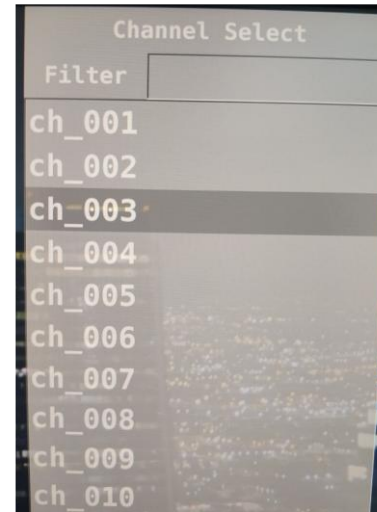

Figure 49: OSD menu

- **Menu Settings** – Use these settings to configure the on-screen display menu:
- **Menu Timeout** (length of time the menu is displayed), **Text Color**, **Background color**, **Hot Key** (the key that opens the menu), **Menu Font Size** and **Menu Position**.
- **Device Information** – The device displays its MAC, IP and the firmware date and version number in the corner of the screen for a limited number of minutes. Set the display time (the timeout) or force it to be displayed permanently. Click **Display Now** to force it onto the screen.
- **Channel List** – The list of encoder streams that can be selected.

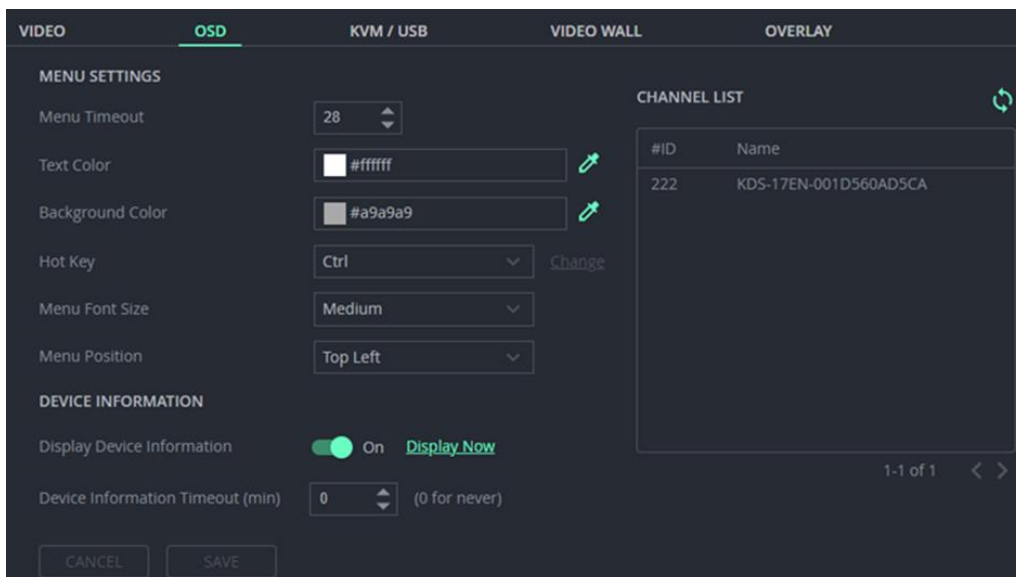

Figure 50: KDS-17DEC Adding the encoder Channel ID and Name

OSD Keyboard Button Functions (for information only, not controllable):

- **Caps Lock:** Double tap to open the OSD menu.
- **Up/Down** (or PgUp/PgDn): Move up/down to the next option.
- Input any word in the Filter textbox: Access to the desired option quickly.

- **Enter:** Make the selection. After Enter is typed, the OSD menu closes.
- **ESC:** Exit the OSD menu.

To define and use the OSD menu

1. Open the decoder webpages. The decoder must output to the display on which the OSD should be displayed.
2. In **AV Settings > OSD**, add the encoder channel ID and name to the channel list.

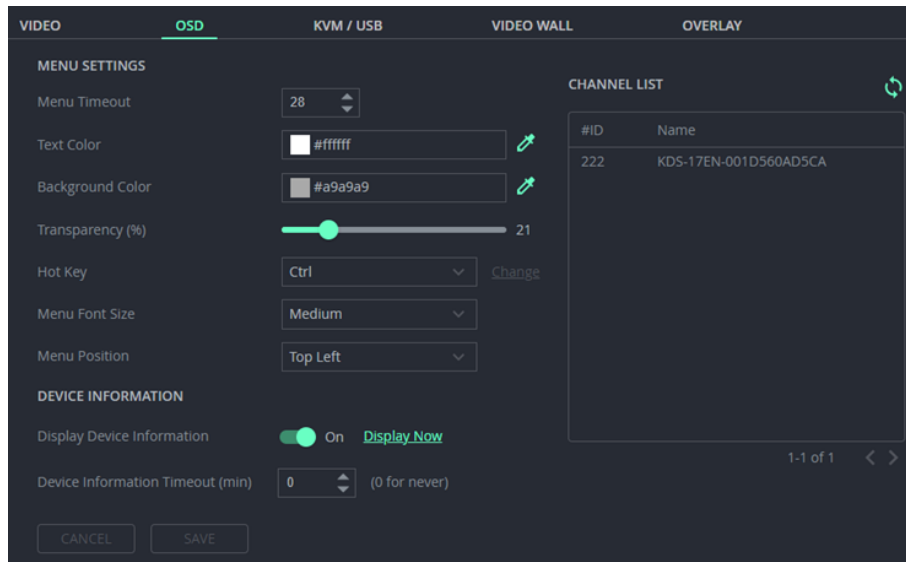

Figure 51: KDS-17DEC Adding the encoder Channel ID and Name

3. Connect a USB keyboard to the USB-A port of the decoder.
4. On the connected keyboard, double click the **Caps Lock**.
The OSD Channel Select page OSD appears, listing 10 channel IDs per page.
5. To operate the OSD, use the Keyboard as follows:
 - Press **Caps Lock** twice to open the OSD.
 - Press **Up/Down** (or **PgUp/PgDn**) to move up/down to the next item.
 - Type a menu feature next to Filter (in the OSD) to access a function quickly.
 - Press **Enter** to accept a selection and exit the OSD menu.
 - Press **Esc** to exit the menu.

OSD menu is accessed.

9.3.3 KVM / USB tab – External Keyboard, Video and Monitor

A KVM or USB keyboard and mouse can be connected to KDS-17DEC and used to control the stream. The encoder will pass a “USB token” which determines which decoder can be used for the keyboard.

KVM Roaming allows for interaction with multiple hosts over USB from one master KDS-17DEC decoder connected to a keyboard and mouse, see the example layout below:

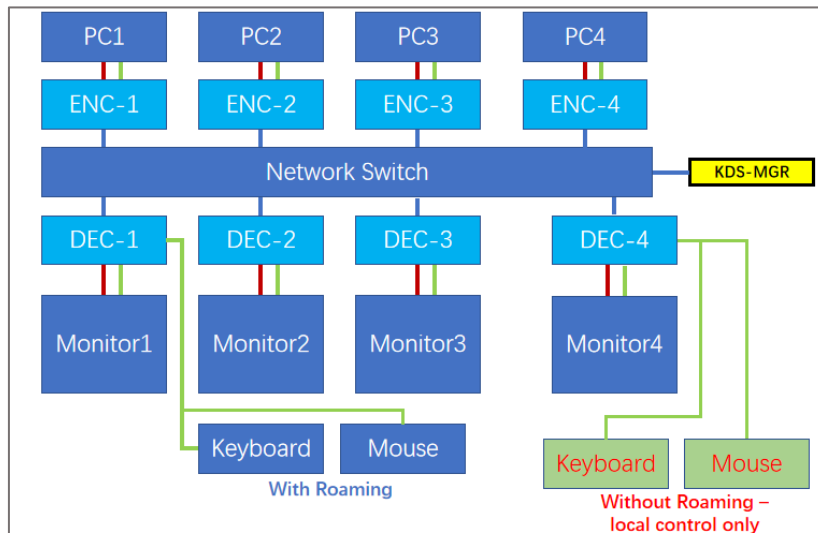

Figure 52: KVM Roaming Layout

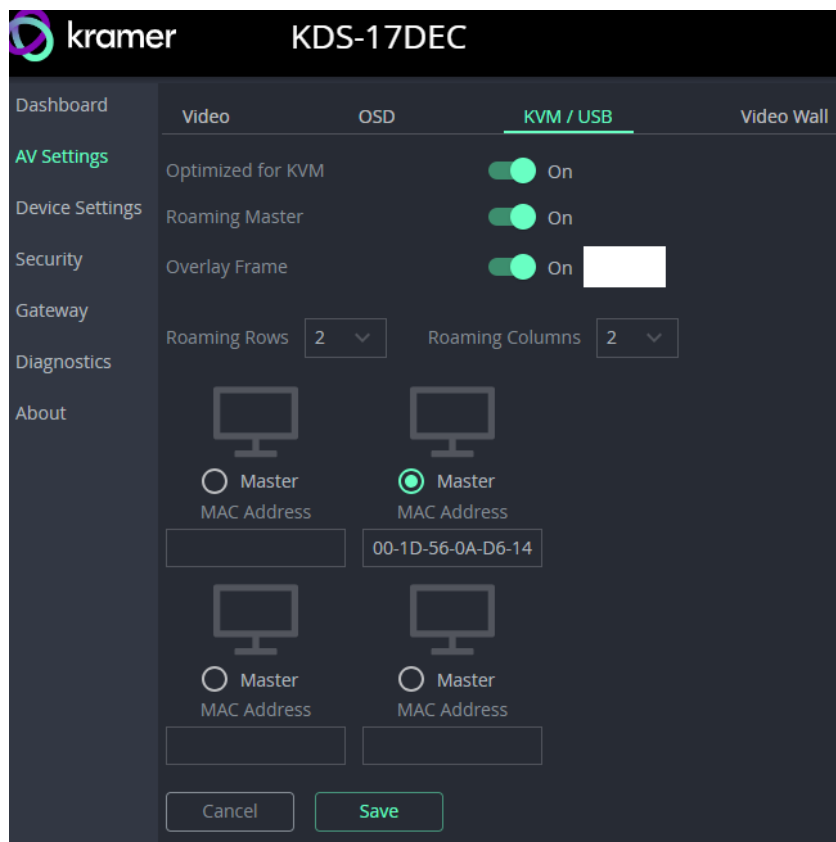

Figure 53: AV Settings – KVM / USB

- **Optimized for KVM** – Enable KVM use and settings. Off allows the USB to be used

for input such as keyboard and mouse or storage (not for webcams), On means that the USB is allocated to KVM use.

- **Roaming Master** – Only available in **Multicast mode** (set in Av Settings > Video) with **Optimized for KVM** enabled. When On, this device can control which decoder will provide the KVM. Enter rows and columns to view additional decoders (enter the decoders MAC address to add it). If this device is set as the “Master”, other connected decoders are shown as “slaves”.
- **Overlay Frame** - The overlay frame displays the roaming mouse that controls the displays. When enabled, it appears in the selected color on the active screen with the mouse. To change the color, click the colored square next to the field.

Configuring KVM Roaming

To configure KVM roaming:

1. Open the encoder and decoder web pages.

2. For each encoder (**KDS-17EN**) **Dashboard**, set a unique **Channel ID** (in the Dashboard) and a unique Device Name in **Device Settings > General**.

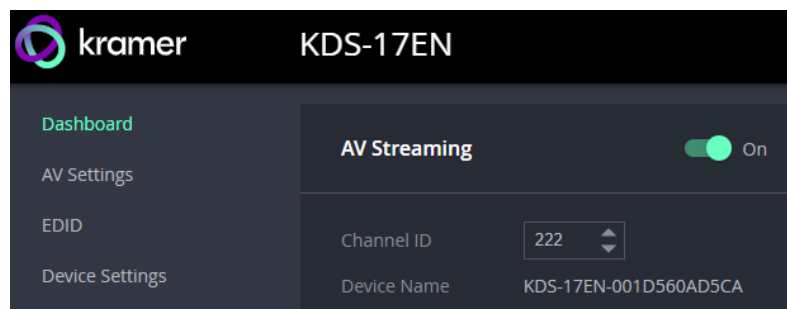

Figure 54: KDS-17EN Setting Channel ID

3. In each decoder (**KDS-17DEC**) **Dashboard**, pair the decoder to an encoder.

For example, pair
ENC 1 to DEC 1,
ENC 2 to DEC 2,
ENC 3 to DEC 3 and
ENC 4 to DEC 4.

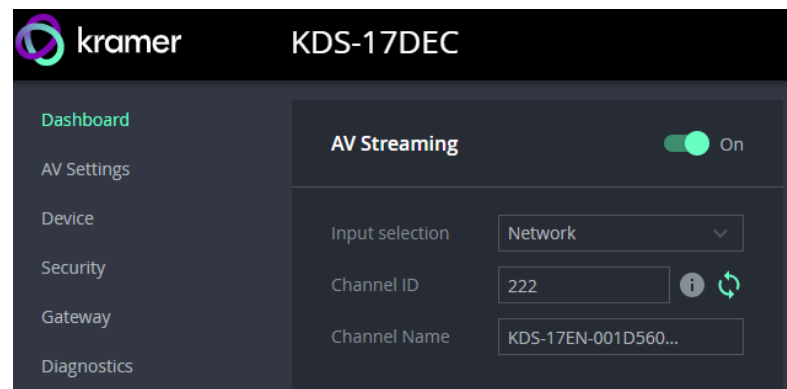

Figure 55: KDS-17DEC Setting Channel ID and Name

4. For the Decoder that has the keyboard and mouse connected, open the **AV Settings > KVM / USB** page.

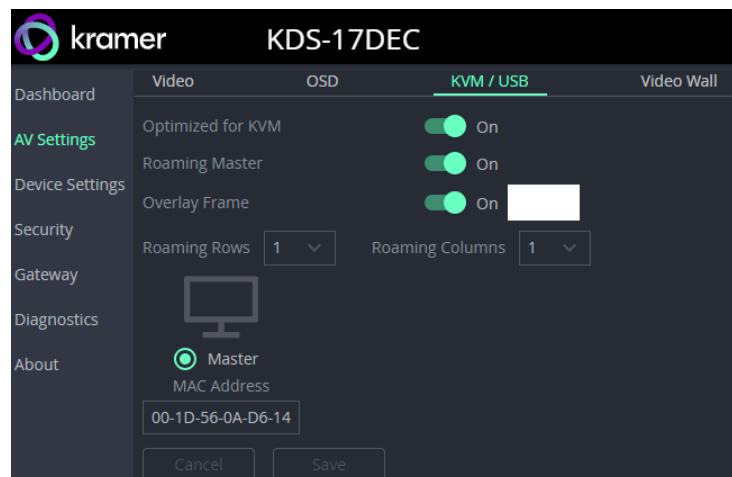

Figure 56: Defining the Master Decoder for KVM Roaming

5. Set the Decoder as “Master”. The decoder configuration setup appears.
6. Set the row and column numbers as they are set physically.
For example, if the decoder setup is a 2x2 video wall, set Row to 2 and Column to 2.

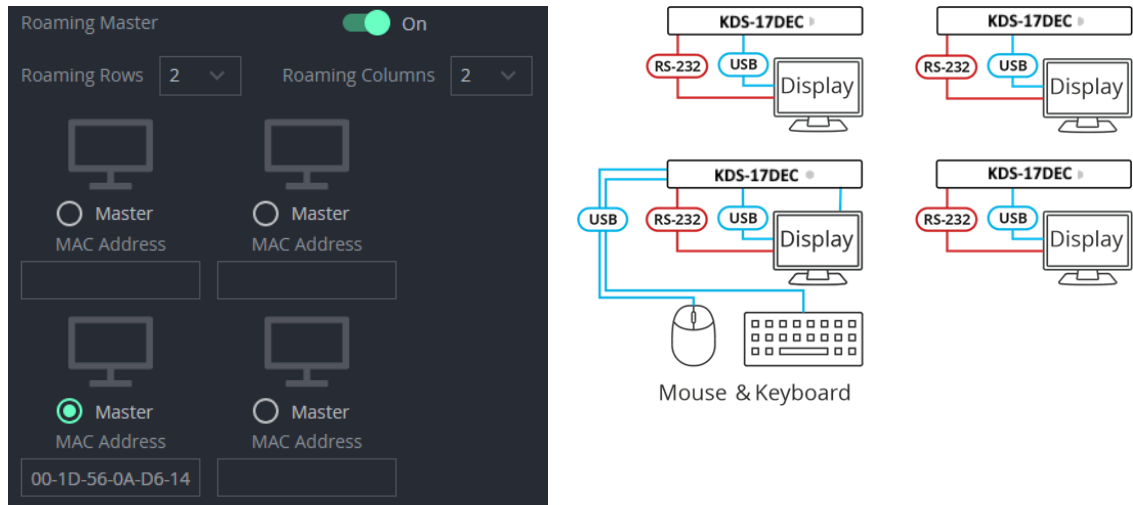



Figure 57: Setting the Decoder Configuration

7. Check the physical location of the Master decoder (lower left size in this example). The MAC address is automatically entered.
 8. Manually enter the other (slave) decoder MAC addresses according to the physical setup.
 9. Click **Save**.
- KVM Roaming is configured.

9.3.4 Video Wall tab – Grid Video Wall / Mosaic Video Wall

Video walls are an array of displays showing a single image. KDS-17DEC supports two types of video wall: Mosaic and Grid. KDS-17DEC can output a section of the AV stream according to its position in the video wall.

Grids are evenly arranged video walls. Mosaic video walls allow displays to be set at different angles.

 • The Mosaic Video Wall configuration is only available on **Panta Rhei's** AV over IP Manager.

- **Vertical Count / Horizontal Count** – The number of displays in the video wall array (maximum 16 vertical and 16 horizontal).
- **Device Relative Position** – Highlight (click) the square corresponding to this decoder's position in the array.
- **Picture Mode** – Stretch or Crop to Fill.
 - **Stretch** stretches the video's aspect ratio to fit the screen (if required).
 - **Crop to Fill** makes no change to the aspect ratio and may leave areas of video outside the screen.
- **Picture Rotation** – Rotate or flip the video output image.

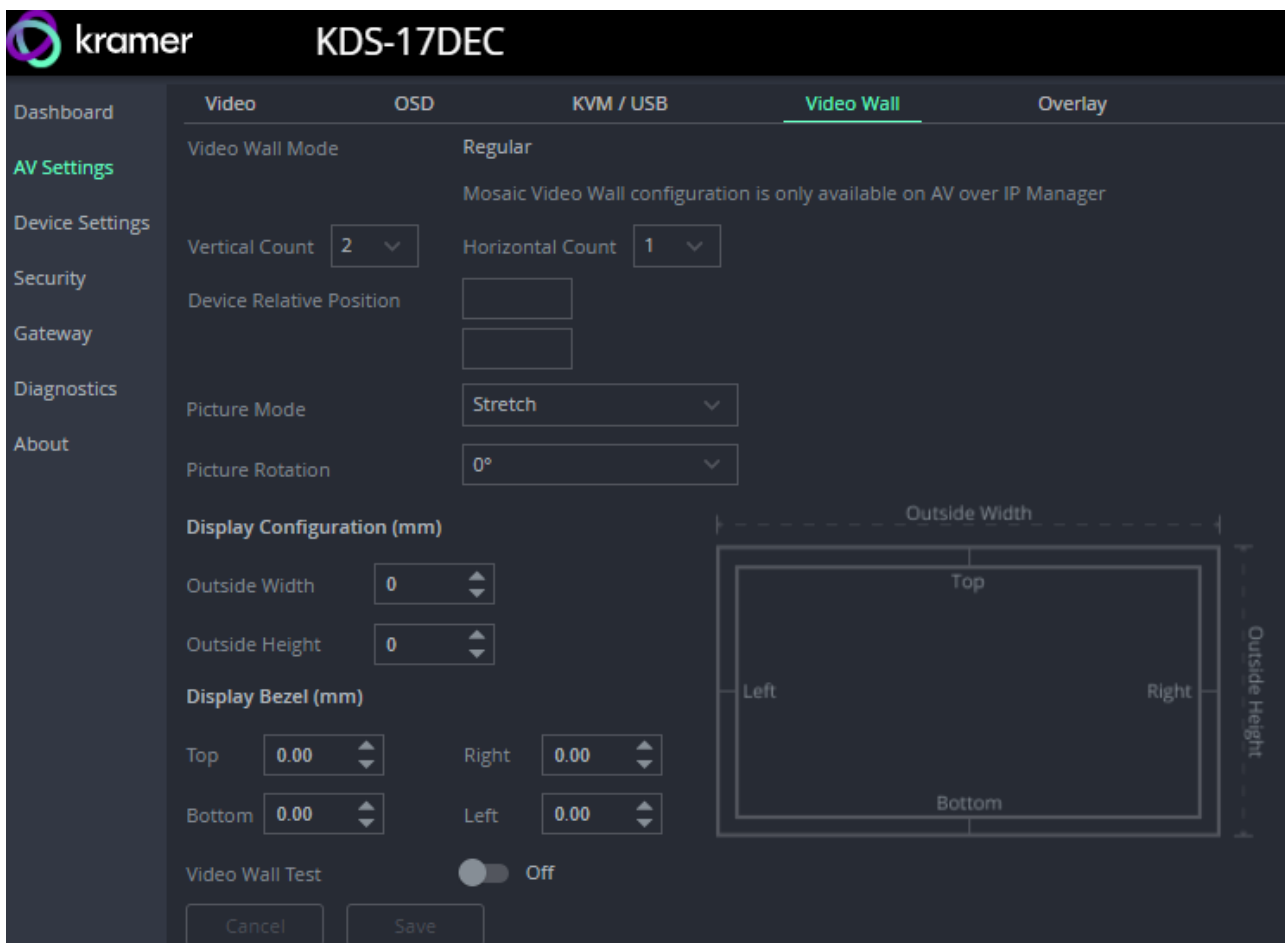

Figure 58: AV Settings – Video Wall

Display Configuration (mm) - Outside Width/Height: The display's outer dimensions.



Figure 59: AV Settings – Video Wall, outside heights

Display Bezel (mm) - The Bezel is the gap between the display's outer dimensions and the output image. Separate values can be entered for the top, bottom left side and right side. Accuracy is to 0.01 mm.

A screenshot of the 'Display Bezel (mm)' settings interface. The title 'Display Bezel (mm)' is at the top. Below it are four input fields, each with a numeric value and up/down arrows. The fields are: 'Top' with '0.00', 'Right' with '0.00', 'Bottom' with '0.00', and 'Left' with '0.00'.

Video Wall Test – Enable to output a test image to the array of displays.

Click **Save** after making changes!

9.3.5 Overlay tab – Overlay an image, text or KVM

Use overlay to display images or text on the screen at the start (or for the entire duration) of a stream.

Note: Overlay transparency is set in the Video tab.

Overlay time (min)

Sets the length of time that the overlay is displayed. If timeout is 0, the test or image are permanently displayed.

Image Overlay

- **Image** – Upload an image. The image must be PNG, maximum size 640 x 360 maximum size 256KB.
- **Align** – Set the image position.

Text Overlay

- **Text** – Enter the text to display.
- **Size** - Small, medium or large.
- **Align** – Set the image position on the screen.
- **Text Color** – Click the square to select a different text color.

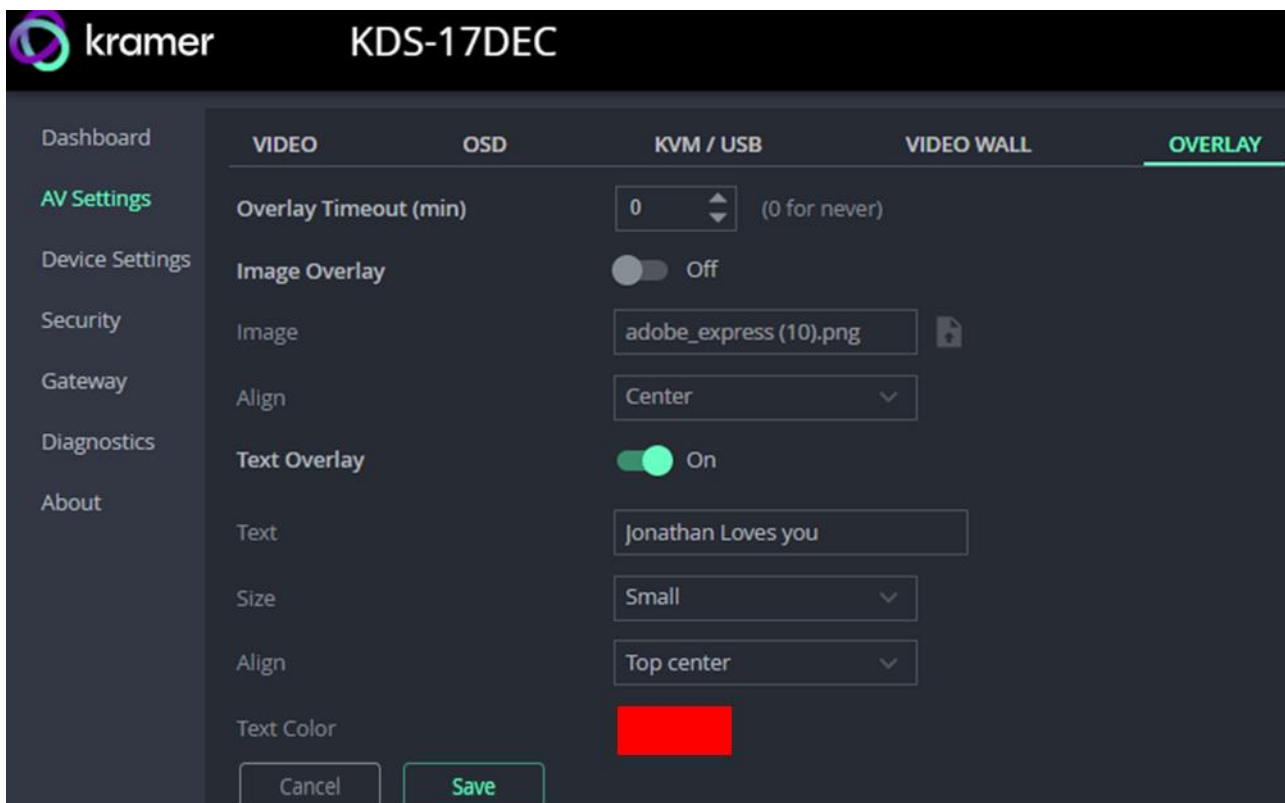

Figure 60: Av Settings - Overlay

9.4 Device Settings: General, Network, Time

The KDS-17DEC Device pane has three tabs:

- **General** – Sets the device’s host name, updates firmware, restarts or resets the device. You can also export or input device settings.
- **Network** – Set the LAN 1 and LAN 2 parameters for the device.
- **Date & Time** – Define an NTP (network time protocol) server or set the time. An NTP server is advisable, as it coordinates the time between all the connected devices.

9.4.1 General tab

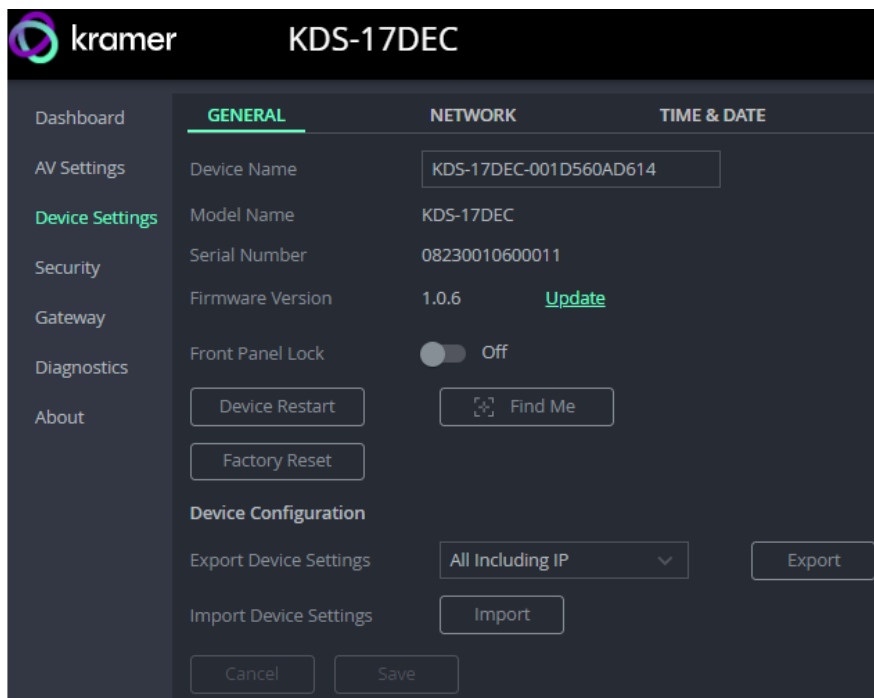

Figure 61: Device pane – General tab

- **Device name** – Edit or view the device’s Host name.
- **Model Name** of the decoder.
- **Serial Number** of the decoder.
- **Firmware Version** – To update the decoder firmware, download the latest version from <http://www.kramerav.com/downloads/kds-17dec> to a local network location and then click **Update** to select and upload it.
- **Front Panel Lock** – Enabling this option prevents use of the LCD Display.
- **Device Restart** – Click to restart **KDS-17DEC** (confirmation will be requested).
- **Factory Reset** - Click to reset the device's operation mode and restart the device (confirmation is requested).
- **Find Me** – The LEDs will flash fast for 60 seconds to identify the decoder.



When an HDMI OUT screen is connected, the screen shows the device’s IP.

- **Device Configuration** –

- **Export Device Settings** – Output a settings file “file.tar.gz”. Settings are stored in JSON format.
- **Import Device Settings** – Import a settings file in the same format as the output file. The device will be reset to the uploaded settings.

9.4.2 Network tab: Using LAN 1 and LAN 2 for different streams

KDS-17DEC has two Ethernet ports, LAN 1 and LAN 2 (see 24 and 25 in [Defining KDS-17DEC](#) on page 8). By default, all network connections use both ports, however you can separate the types of stream sent to/from each port and give each port a separate IP address. For example, use one port for AV and the other for control commands such as P3K (P3000 API) commands.



Figure 62: KDS-17DEC - Device Settings pane – Network Tab

Ethernet Bridge Mode – Enable if you want to enable a connected third party device to access the network.

- **Bridge Port** – LAN 1 or LAN 2. When enabled, the port used as a bridge cannot be used for the Control, (AV) Stream or Dante streams
- **VLAN ID** – Ethernet data tagged with the selected VLAN ID will be allowed to reach the bridge port.

IP Address Settings –

- **Service Name -**
 - **Control** is for PK3000 commands, RS-232 and IR data.
 - (AV) **Stream** is for the AV stream.
 - **Dante** (Digital Audio Network Through Ethernet) is for transmitting high-quality digital audio over Ethernet.
- **Port** – LAN 1 or LAN 2. The Ethernet port used by the service.
- **802.1Q** – If set to On (off by default), the data transmission uses VLAN tags.

- **VLAN Tag** – VLAN (virtual local area network) tags (range 2 – 4000) are used to separate the network into smaller virtual networks. Requires **802.1Q** to be set to On. If Ethernet Bridge Mode is enabled, none of the streams can use its VLAN ID.
- **CoS** – Class of Service, requires a unique VLAN tag. CoS sets the priority (0-7) of each of the VLAN options within the local network (layer 2 of the OSI model). Higher priority traffic is prioritized and provides a more reliable service. If the stream and the control share the same LAN, the control is always CoS 5. Dante always has CoS 0.
- **DSCP** – The DSCP (Differentiated Services Code Point) value is used to mark the priority (0-63) of packets in a WAN network layer (layer 3 of the OSI model). It is used for large-scale networks (or across the Internet) and increases the quality of service. By default SCP is 56 for the Control stream and 46 for Dante always has a DSCP of 46 (even if 802.1Q is off).
- **DHCP** – If set to On, the service’s IP address is generated automatically. If set Off, you may need to define a static IP address for the service.

To separate Control streams from the AV stream

1. Change the following settings in the **IP Address Settings** section of the **Network** tab (see [Figure 62](#) for more information):
 - In the **Control** row’s **Port** column select **LAN 2** and set **802.1Q** to **On**.
 - In the **VLAN Tag** column, enter an integer number (2 - 4000) for Control services. This separates the Control packets.



802.1Q and VLAN are not required for Dante.

2. To use a static IP for LAN 2, set DHCP to **Off** and enter a subnet mask and gateway address. If no static IP is defined, the DHCP server will allocate the IP.

If no DHCP server exists in the system, the device will look for a random unique IP in the range of 169.254.X.Y. The allocated IP address is shown in the IP address field.

To separate Dante/AES67 Audio from the AV streams:



In this screen, Dante is also used for AES67 streams.

For more information, see [Defining Dante Audio as an Audio Source or Destination on page 77](#).

1. To export Dante audio from the decoder, you must first go to the KDS-17DEC **Dashboard** pane and set the **Audio Streaming** Dante OUT to On (see [Audio OUT: Set the audio output on page 49](#)).
2. To import Dante audio from the encoder, you must first go to the KDS-17DEC **Dashboard** pane and set the **Routing** to Play Audio from Dante (see [Audio OUT: Set the audio output on page 49](#)).
3. In the KDS-17DEC **Device Settings** pane, open the **Network** tab.

In the **IP Address Settings**, set the **Dante** row’s **Port** column to LAN 2 and set **802.1Q** to **On**.

In the **VLAN ID** column, enter an integer number (2 - 4093) for Dante services. Make sure this is different from the number used for the Control packets.

 802.1Q and VLAN are not required for LAN 1.

4. To use a static IP for LAN 2, set DHCP to **Off** and enter a subnet mask and gateway address. If no static IP is defined, the DHCP server will allocate the IP.

Dante audio output is now defined.

9.4.3 Time & Date tab

To sync device time and date from a network time server:

1. In the **Device** pane, select the **Date & Time** tab.
2. Set the **Time zone**.
3. Set **Use Time Server (NTP)**, to On.
4. Enter the **Time Server Address** IP.
5. Click **SAVE**.

The devices date and time are synchronized to the server address entered.

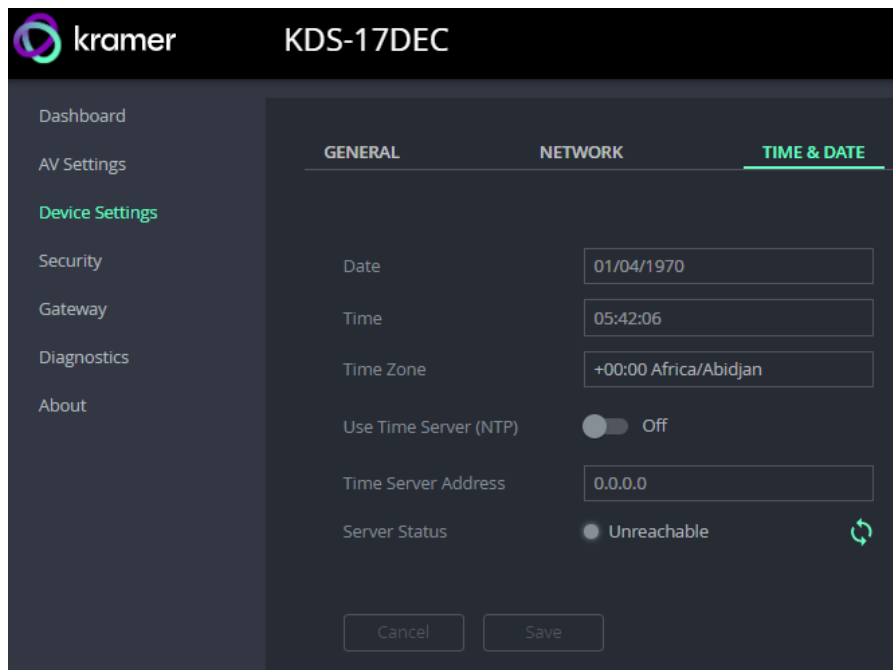



Figure 63: Device Settings pane – Time & Date tab

9.5 Security: Passwords, HTTPS and 802.1X

 Password protection of the web pages is only active when the Security Status is On (the default state). The default password is “admin”.

If you change the password, the new password must include a number, a special character and both upper and lower-case letters (no commas or spaces).

The KDS-17DEC Security pane has three tabs:

- **Device Security** – Enable/disable security and change the device password.
- **HTTPS** – Use the device’s internal certificate or upload a local certificate.
- **802.1X**- Enable and setup IEEE 802.1X authentication.
- **AES256** – Set the level of AES256 encryption.

9.5.1 Device Security tab: Enable Password Control

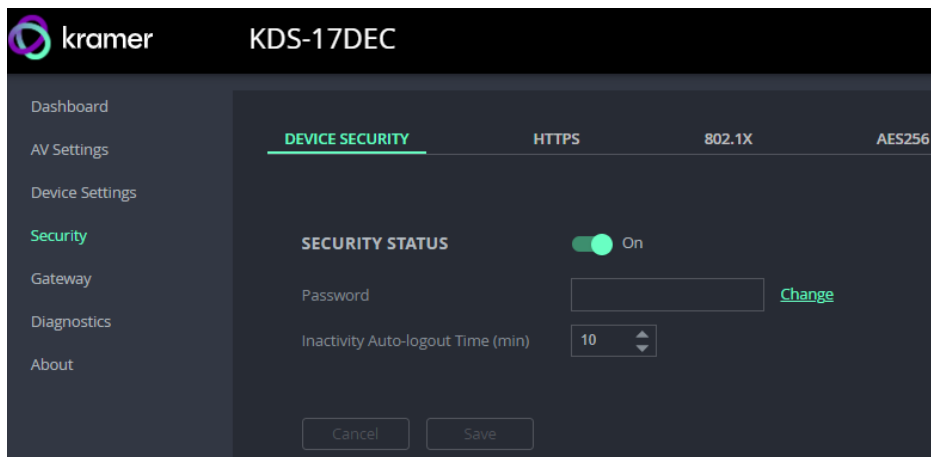

Figure 64: Security pane – Device Security tab

To change Security Status

When security is enabled, access to the web pages requires entry of a password. Changes to the security status require entry of the device’s current password (default: “admin”).

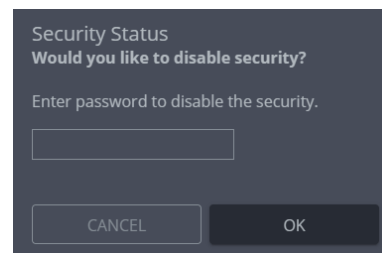

Figure 65: Security pane – pop-up

To change the password

Password protection is only available if the **Security Status** is On. To change the password, enter the **Current Password** and then click **Change**. The new password must include a number, a special character and both upper and lower-case letters (no commas or spaces).

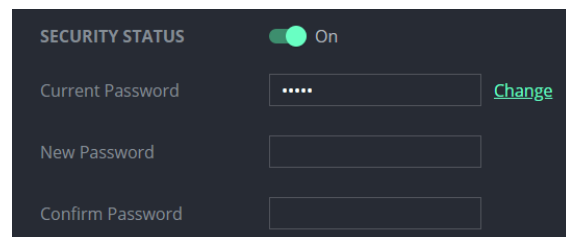



Figure 66: Security pane – Change password

9.5.2 HTTPS tab

To configure HTTPS:

1. In the **Security** pane's **Device Security** tab, **Security Status** must be enabled.
2. Select the **HTTPS** tab.
3. Enable HTTPS STATUS and select one of the following authentication methods:
 - **Internal Certificate** – Use the factory default certificate for authentication.
 - **Server Certificate** – Submit a certificate from the server for authentication (assigned by your network administrator). Click  to upload the certificate. Enter the private key password.

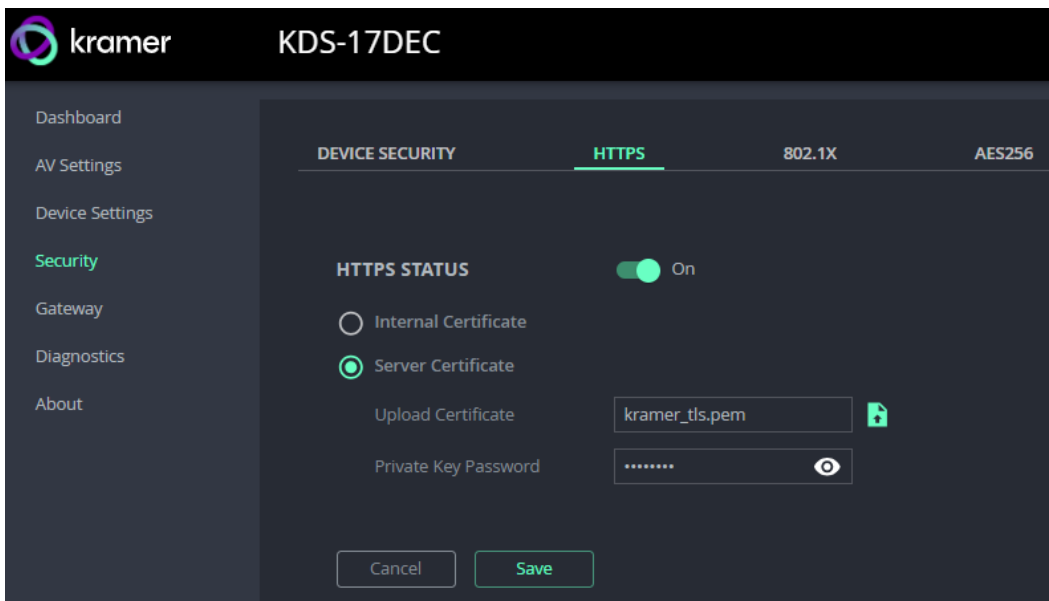

Figure 67: Security Tab – Server Certificate

4. Click **SAVE**.
HTTPS is configured.

9.5.3 802.1X tab

802.1X authentication must be defined separately for LAN 1 and LAN 2. 802.1X is a port-based authentication protocol, that uses a RADIUS network access server to authenticate devices accessing the network. It must be configured separately for LAN 1 and LAN 2.

To configure IEEE 802.1X Authentication:

1. In the **Security** pane, select the **802.1X** tab.

LAN 1 / LAN 2 - LAN 2 has identical settings and is at the bottom of the screen. Enable and configure LAN 1 and LAN 2 separately.

2. Set 802.1x authentication **ON**.

3. **Authentication Status:**

- Green – LAN is using 802.1X and authentication has succeeded.
- Orange – LAN is using 802.1X and authentication is in process.
- Red – LAN is using 802.1X but authentication has failed.
- Grey – 802.1X is disabled.

4. Check one of the following settings:

- **EAP-MSCHAP V2** – To use this authentication method, enter the KDS-17DEC username and password.
- **EAP-TLS** – Submit a certificate from your network authentication server: Enter the KDS-17DEC Username (“admin”) and click  to upload the Client Certificate and Private Key. Enter the Private Key Password (assigned by the network administrator).

5. **Server Certificate** – (optional) Use a CA (certification authority) issued certificate to authenticate the RADIUS server. Enable and click  to upload the CA certificate.

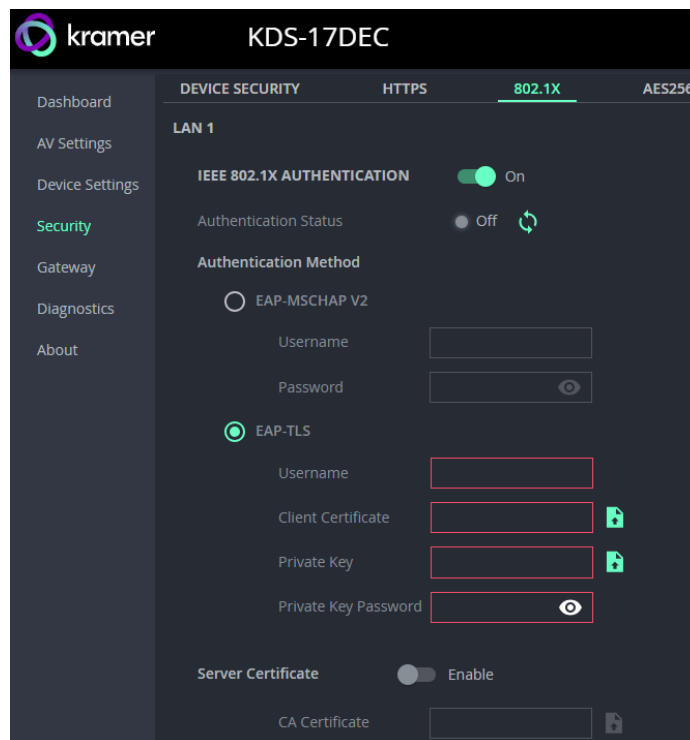

Figure 68: EAP-TLS – Certificates and Password

6. Repeat for LAN 2 if necessary.

7. Click **SAVE**: 802.1X is configured.

9.5.4 AES256 tab

When Device Security is enabled, AES256 encryption is used to encrypt packet headers, Use AES256 Full to encrypt the whole packet. By default, a system key is used for encryption and decryption. If you want to enter a custom key, key make sure both encoder and decoders are updated to use the same key.

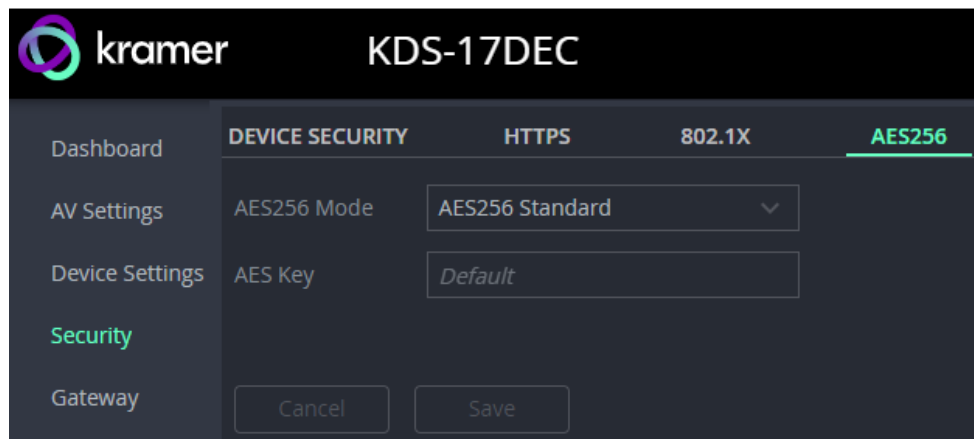

Figure 69: Security pane – AES256 tab

AES256 Mode: Standard or Full.

- **Standard** encrypts the packet headers into blocks of 128 bits each.
- **Full** encrypts the entire packet and requires that Jumbo Frames are enabled on the switch, so that the transmitted IP packet is not larger than the maximum Ethernet frame.

AES KEY: Default or customized.

- **Default** uses 14 rounds of processing to create a device defined 256-bit key.
- **Customized** requires you to enter a 32-byte hexadecimal string (64 characters using only the characters 0 – 9 and A to F). No hex code identifier is required before the string.

9.6 Gateway: CEC, RS-232 and IR definitions

The KDS-17DEC **Gateway** pane has three tabs:

- **CEC** – Enable and setup the direction of CEC commands.
- **RS-232** – Enable and configure RS-232 communication.
- **IR**- Setup direction of pass-through IR (infrared) controls.

9.6.1 CEC tab: Configuring CEC commands

CEC (Consumer Electronics Control) commands are sent from an HDMI device to the devices connected to it and enable a single HDMI device to control its connected environment.

KDS-17DEC can receive CEC commands over LAN from the encoder and send them on to the CEC enabled device that is connected to its HDMI output.

To set **CEC Gateway**:

1. In the Gateway pane, click **CEC**.

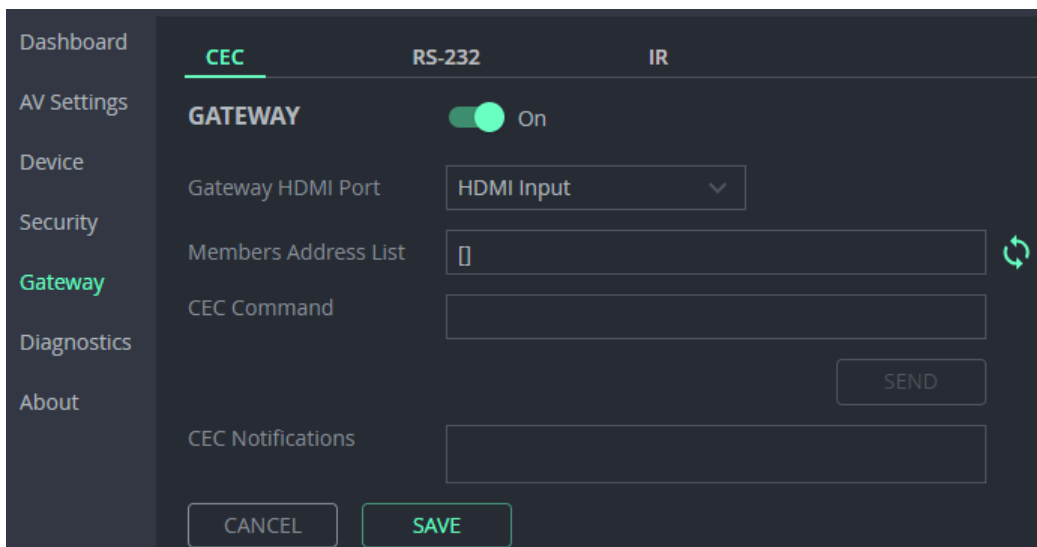



Figure 70: Control > Settings Page – CEC Settings

2. **Enable** the CEC gateway.
3. Select the HDMI port to which CEC commands are sent:
 - HDMI Input (HDMI IN).
 - HDMI Output (HDMI OUT).
4. Click refresh , to see the address of the CEC device that is attached to the HDMI port.
5. Enter the CEC command in hexadecimal format.
6. Click **SEND**.
7. View the CEC-enabled device response in the **CEC Notifications** field.

CEC Gateway is configured.

9.6.2 RS-232 tab

KDS-17DEC can receive RS-232 commands sent to a remotely connected decoder's RS-232 port. These commands can be used to remotely control KDS-17DEC.

To set RS-232 Gateway:

1. In the Gateway pane, click the **RS-232 tab**.

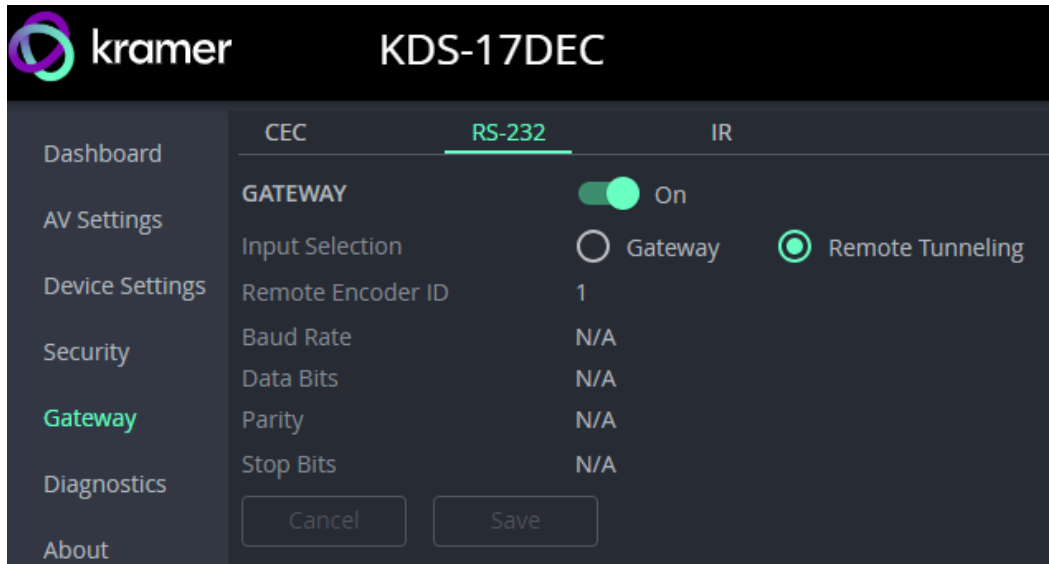

Figure 71: Gateway > RS-232

2. **Gateway** - Enable (or disable) the RS-232 gateway.
3. **Input Selection** – Gateway or Remote Tunneling.
 - **Gateway:** (Default) Transmits or receives RS-232 serial commands (or data) to or from devices connected to the decoder.
 - **Remote Tunneling:** RS-232 serial commands/data are encapsulated within a different protocol for transmission over Ethernet. Use this to transmit commands/data between the encoder and decoder.
 - When Remote Tunneling is selected, the following RS232 parameters on the decoder are unconfigurable and follow that of the associated encoder.
 - When switching back from Remote Tunneling to Gateway, click **Save** to enable editing of the RS-232 parameters.
4. Define the RS-232 gateway port (5001, by default).
5. Enter the Baud Rate: 1200 to 115200 (default).
6. Enter the Data Bits: 5, 6, 7 or 8 (default).
7. Enter Parity: None (default), Odd or Even.
8. Enter Stop Bits: 1 (default) or 2.

8. Click **SAVE**.

RS-232 Gateway is configured.

9.6.3 IR tab

KDS-17DEC can send or receive IR commands over LAN, to or from the connected encoder. The IR signals can be used to control a relevant device. The IR direction should be the opposite of that specified on the encoder.

To set RS-232 Gateway:

1. In the Gateway pane, select the **IR** tab.

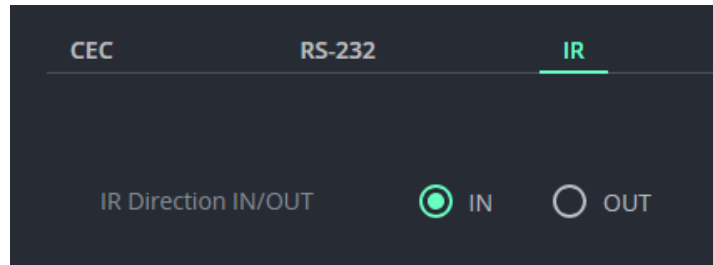

Figure 72: Control > Settings Page – IR Settings

2. Set IR direction:
 - **IN** – Configure the IR port as an input port that is connected to an IR receiver cable.
 - **OUT** – Configure the IR port as an output port that is connected to an IR emitter cable.

IR Gateway is configured.

9.7 Diagnostics: Status and Connections

The KDS-17DEC **Diagnostics** pane has three tabs:

- **STATUS** – View the device’s activity state, temperature, and output ports.
- **CONNECTION** – View the device’s active network connections.

9.7.1 Status tab

1. In the Diagnostics pane, click **Status**.

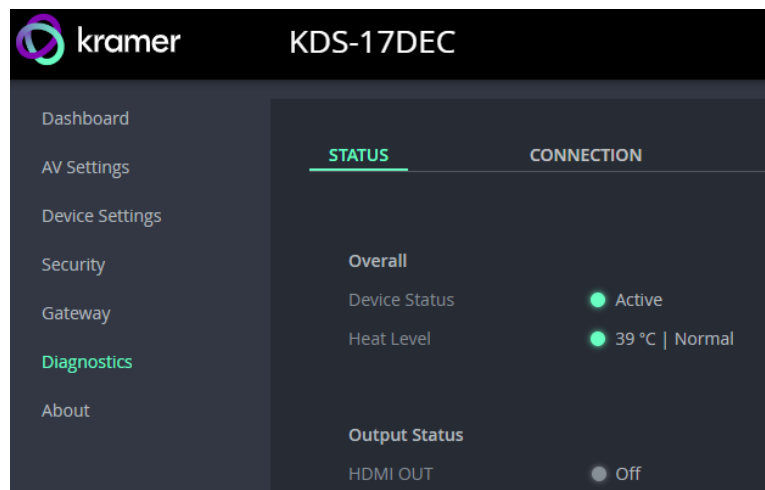

Figure 73: Diagnostics – Status Tab

2. Device Status:
 - **Active**, for normal operation (green indication).
 - **Standby**, when device is powered off, booting or in standby mode.
3. Heat Level:
 - **Normal**, for temperatures under 45°C.
 - **High**, for temperatures between 45°C and 60°C.
 - **Overheat**, for temperatures higher than 60°C.
4. View the status of the outputs:
 - **HDMI OUT** - On, the output channel is transmitting an active signal.

Device status is viewed.

9.7.2 Connection tab

View the network device's connected to the device.

To view Connections status:

1. In the Diagnostics pane, click **Connection**.
2. Select the Connections tab.

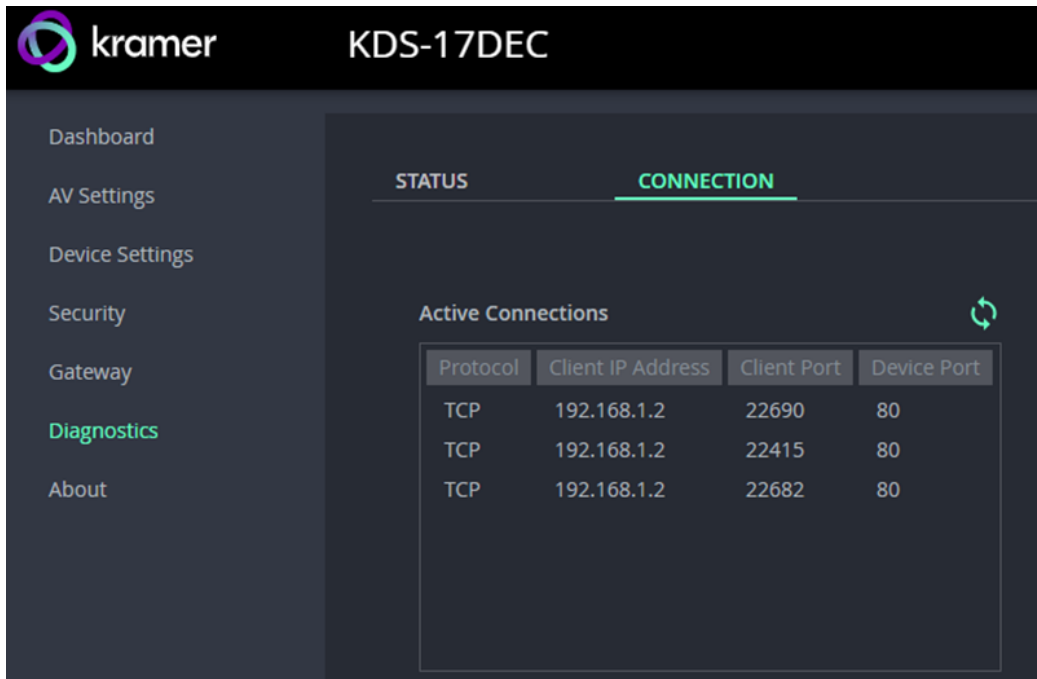

Figure 74: Diagnostics – Connection Tab

3. UCP devices that end the connection will be displayed for 10 minutes after the connection ends.

Connections' status is viewed.

9.8 About

View the device model, hardware release, firmware version and Kramer Electronics Ltd details.

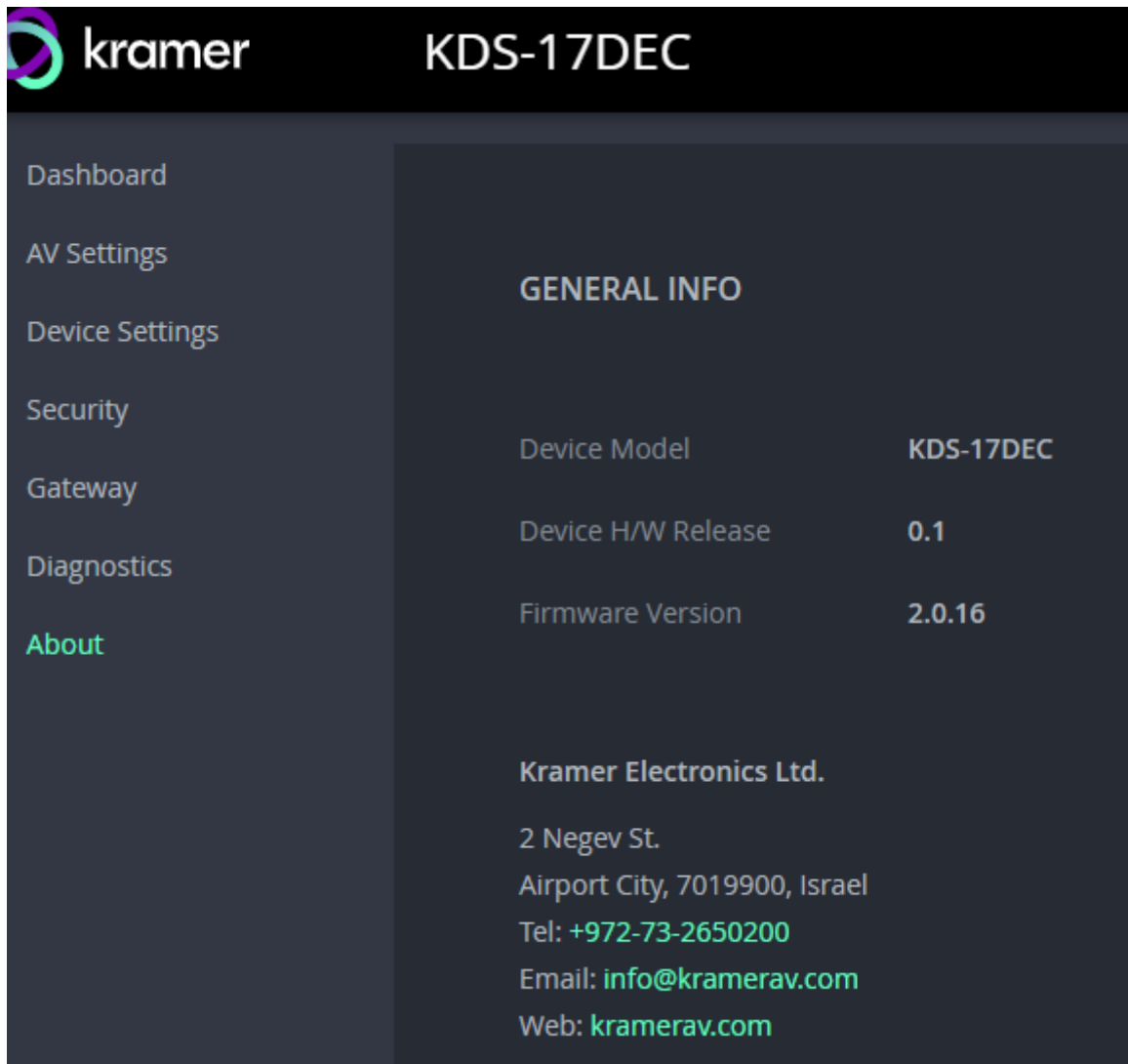

kramer KDS-17DEC

- Dashboard
- AV Settings
- Device Settings
- Security
- Gateway
- Diagnostics
- About**

GENERAL INFO

Device Model	KDS-17DEC
Device H/W Release	0.1
Firmware Version	2.0.16

Kramer Electronics Ltd.

2 Negev St.
Airport City, 7019900, Israel
Tel: **+972-73-2650200**
Email: **info@kramerav.com**
Web: **kramerav.com**

Figure 75: About Page

9.9 Upgrading Firmware

Upgrade the firmware, view the date of the last upgrade, or rollback to the previous firmware revision in case of a problem.



Click **ROLLBACK** to update to the previous FW version.



If the device firmware version is lower than 0.6.3, contact Kramer tech support team at support@kramerav.com or go to our Web site at <http://www.kramerav.com/downloads/kds-17dec>

To upgrade the firmware:

1. In the Navigation pane, Select **Device Settings**. The General tab in the Device Settings page appears.

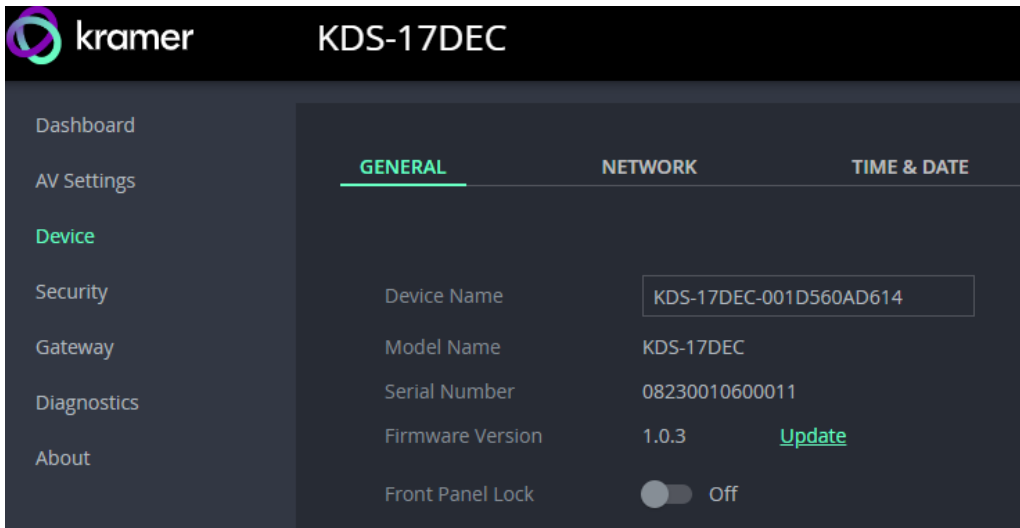

Figure 76: General Tab – Upgrading the Firmware

2. Next to Firmware Version, click **Update**. The Open window appears.
3. Select the FW file and click **Open**. The FW upgrade pop-up window appears. Wait for upgrade completion.
4. Once completed, refresh the web page and log-in.

Firmware upgrade is complete.

10 Defining Dante Audio as an Audio Source or Destination

Dante is a professional audio over Ethernet technology and is designed for transmission of multiple audio channels over relatively long distances or to many locations.

10.1 Defining Dante input to the KDS-17EN encoder

KDS-17EN can import a Dante audio stream and output it to the decoder.

1. In the KDS-17EN webpages, open the KDS-17EN **Dashboard** pane.
2. In the **Device Audio Routing** field group, set the relevant **INPUTS** to **Dante** (see [Dashboard: Overview of Streaming](#) on page 25).
3. In the **Audio OUT** field group, enable **Dante OUT**.
4. Open the KDS-17EN **Device Settings** pane and select the **NETWORK** tab.
5. In the NETWORK tab's **IP Address Settings** field group, find the Dante row and set the relevant settings (see [To separate Dante/AES67 Audio from the AV streams:](#) on page 34).

10.2 Defining Dante output from the KDS-17DEC decoder

KDS-17DEC can import a Dante audio stream and output it in another format or output audio as a Dante audio stream.

1. In the KDS-17DEC webpages, open the KDS-17DEC **Dashboard** pane:
 - a. To import Dante audio, in Audio OUT, set **Routing** to play audio from **Dante** (see [Dashboard: Overview of Streaming](#) on page 25).
 - b. To export Dante audio, in Audio OUT, set **Audio Streaming** Dante OUT to On.
2. Open the KDS-17DEC **Device Settings** pane and select the **NETWORK** tab.
3. In the NETWORK tab's **IP Address Settings** field group, find the Dante row and set the relevant settings: see [To separate Dante/AES67 Audio from the AV streams:](#) on page 64.

10.3 Using Dante Software

To input or output Dante audio with **KDS-17EN** or **KDS-17DEC**:

1. Download and install **Dante Controller** software from <https://my.audinate.com/support/downloads/dante-controller>.
2. Open **Dante Controller** software on a laptop connected to the same LAN switch as **KDS-17EN**.
Dante Controller opens in **Network View** with the **Routing** tab open and lists the Dante

enabled devices it has detected on the network. Receivers are shown on the left and transmitters on the top.

- **To connect a unicast flow** (stream) between a transmitter and receiver click on the intersection between them.
- **To create a multicast flow:**
 - a. Open the **Device Info** tab.
 - b. Double click the KDS-17EN/KDS-17DEC device to open the **Device View** screen.



Figure 77: Dante Controller screen (section)

- c. If using AES67, click the **AES67 Config** tab and enable AES67 Mode; You will be prompted to reboot (restart) **Dante Controller** (repeat steps a and b after restarting).



Figure 78: Device View screen - AES67 Config tab

- d. Select the **Receive** tab and click the Flow icon to create an audio flow (stream).

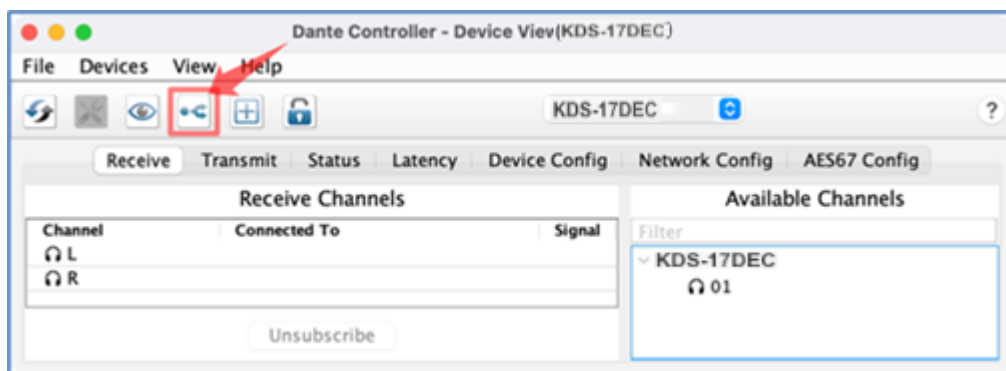

Figure 79: Device View screen – Flow icon

- e. The **Create Multicast Flow** dialog box opens. Select the flow type (Dante or AES67), the channels and press the **Create** button.

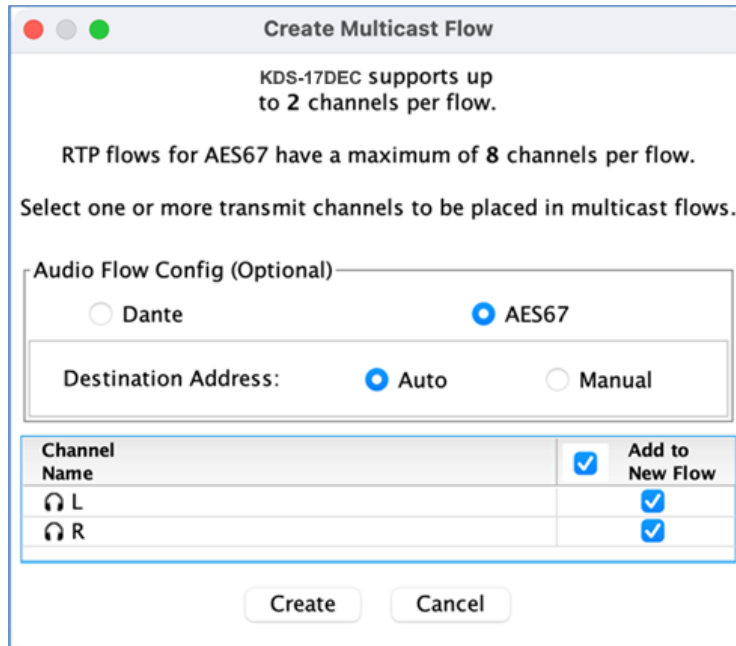

Figure 80: Device View screen – Create Multicast Flow box

f. An RTP multicast flow is created and will be visible in **Transmit** tab.

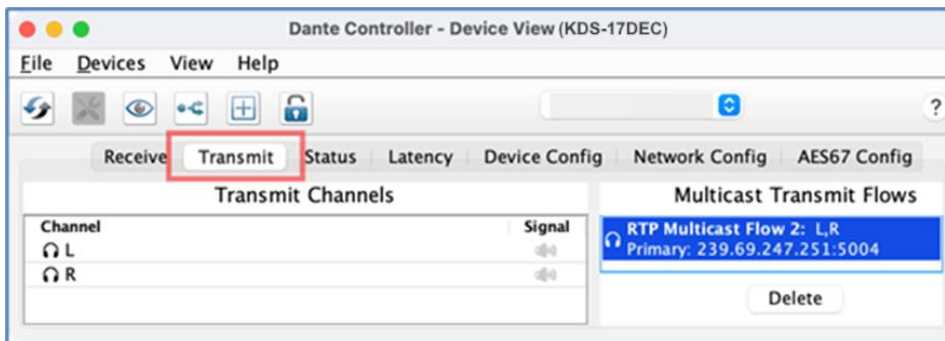

Figure 81: Device View screen – RTP Multicast Flow in the Transmit tab

g. Use the **Dante Controller** software to route the audio between the encoder/decoder and the Dante source or destination.

Dante has been defined.

11 Technical Specifications

11.1 KDS-17EN Specifications

Inputs	1 HDMI	On a female HDMI connector		
Outputs	1 HDMI	On a female HDMI connector		
Ports	1 Ethernet	On an RJ-45 connector		
	1 Ethernet	On an SFP optical/copper transceiver port		
	1 Balanced Audio	On a 5-pin terminal block connector		
	1 RS-232	On a 3-pin terminal block connector		
	1 IR	On a 3.5mm TRS connector		
USB	1 USB-B Host	Connecting USB 3.0 PC/laptop		
	2 USB-A Devices	Connecting USB 3.0 local devices		
	1 Level USB Hub	When connecting to KDS-17DEC		
Network	Multicast	Through RTSP (Real Time Streaming Protocol): IGMP snooping non-blocking, Layer 2		
	Unicast	Through RTSP (Real Time Streaming Protocol)		
	Bitrate	Peak: 850Mbps, 4K average: 350Mbps, 1080p average: 250Mbps		
Video	Compression Standard	JPEG2K-Like, private stream		
	Max Resolution	4K@60Hz (4:4:4)		
	HDR 10	Up to 4K30 4:2:2 12 bit		
	HDCP	1.4 and 2.2 supported		
	EDID	Passthrough, output resolution, predefined default EDID, or custom EDID		
Resolution	4096x2160@60Hz 3840x2160@60Hz 1920x1200@50Hz 1920x1080@60Hz 1856x1392@60Hz 1792x1344@60Hz 1680x1050@60Hz	1600x1200@60Hz 1600x900@60Hz 1440x900@60Hz 1400x1050@60Hz 1366x768@60Hz 1360x768@60Hz	1280x960@60Hz 1280x800@60Hz 1280x768@60Hz 1280x720@60Hz 1224x768@70Hz 1152x864@70Hz 1024x768@60Hz	848x480@60Hz 800x600@60Hz 720x576@60Hz 720x480@50Hz 640x480@60Hz 640x400@85Hz 640x350@85Hz
Audio	Supported Formats	LPCM Dolby DTS	Up to 7.1/24-bit/192kHz Dolby Atmos™, Dolby TrueHD, Dolby Digital Plus™, Dolby Digital EX, Dolby Digital 5.1, Dolby Digital 2/0 Surround, Dolby Digital 2/0 DTS-HD Master Audio™, DTS-HD, DTS-ES Discrete 6.1, DTS-ES Matrix 6.1, DTS Digital Surround 5.1	
Security	HTTPS, 802.1x, OWASP-10, AV Streaming: AES256 encryption			
User Interface	Indicators	LINK, NET and ON LEDs, front panel LCD Display		
	Rear Panel	Restart and factory reset button		
	Controls	Embedded web pages, P3K API commands via Ethernet, front panel navigation buttons		
Power	PoE+	37V to 57V, max power 15W		
	Optional Power Supply	20V DC, 6A		
Environmental Conditions	Operating Temperature	0° to +45°C (32° to 113°F)		
	Storage Temperature	-20° to +70°C (-4° to 158°F)		
	Humidity	10% to 90%, RHL non-condensing		
Regulatory Compliance	Safety	CE, FCC		
	Environmental	RoHs, WEEE, UKCA		
Enclosure	Size	Mega Tool Deep		
	Type	Aluminum		
	Cooling	Convection Ventilation		
Dimensions	Net Dimensions (W, D, H)	18.9cm x 14.5cm x 2.76cm (7.44" x 5.71" x 1.09")		
	Shipping Dimensions (W, D, H)	31.2cm x 17.9cm x 7.6cm (12.28" x 7.05" x 2.99")		
Weight	Net Weight	0.7kg (1.54lbs) approx.		
	Shipping Weight	0.9kg (2lbs) approx.		
Specifications are subject to change without notice at www.kramerav.com				

11.2 KDS-17DEC Specifications

Inputs	1 HDMI	On a female HDMI connector			
Outputs	1 HDMI	On a female HDMI connector			
Ports	1 Ethernet	On an RJ-45 connector			
	1 Ethernet	On an SFP optical/copper transceiver port			
	1 Balanced Audio	On a 5-pin terminal block connector			
	1 RS-232	On a 3-pin terminal block connector			
	1 IR	On a 3.5mm TRS connector			
USB	2 USB-A Devices	Connecting USB 2.0 local devices			
	1 Level USB Hub	When connecting to KDS-17EN			
Network	Multicast	Through RTSP (Real Time Streaming Protocol): IGMP snooping non-blocking, Layer 2			
	Unicast	Through RTSP (Real Time Streaming Protocol)			
	Bitrate	Peak: 850Mbps, 4K average: 350Mbps, 1080p average: 250Mbps			
Video	Compression Standard	JPEG2K-Like, private stream			
	Max Resolution	4K@60Hz (4:4:4)			
	HDR 10	Up to 4K30 4:2:2 12 bit			
	HDCP	1.4 and 2.2 supported			
	EDID	Passthrough, output resolution, predefined default EDID, or custom EDID			
Resolution	4096x2160@60Hz, 3840x2160@60Hz, 1920x1200@50Hz, 1920x1080@60Hz, 1856x1392@60Hz, 1792x1344@60Hz, 1680x1050@60Hz,	1600x1200@60Hz, 1600x900@60Hz, 1440x900@60Hz, 1400x1050@60Hz, 1366x768@60Hz, 1360x768@60Hz,	1280x960@60Hz, 1280x800@60Hz, 1280x768@60Hz, 1280x720@60Hz, 1224x768@70Hz, 1152x864@70Hz, 1024x768@60Hz,	848x480@60Hz, 800x600@60Hz, 720x576@60Hz, 720x480@50Hz, 640x480@60Hz, 640x400@85Hz, 640x350@85Hz	
Audio	Supported Formats	LPCM up to 7.1/24-bit/192kHz Dolby Atmos™, Dolby TrueHD, Dolby Digital Plus™, Dolby Digital EX, Dolby Digital 5.1, Dolby Digital 2/0 Surround, Dolby Digital 2/0 DTS-HD Master Audio™, DTS-HD, DTS-ES Discrete 6.1, DTS-ES Matrix 6.1, DTS Digital Surround 5.1			
Security	HTTPS, 802.1x, OWASP-10, AV Streaming: AES256 encryption				
User Interface	Indicators	LINK, NET and ON LEDs, front panel LCD Display			
	Rear Panel	Restart and factory reset button			
	Controls	Embedded web pages, P3K API commands via Ethernet, front panel navigation buttons			
Power	PoE+	37V to 57V, maximum power 15W			
	Optional power supply	20V DC, 6A			
Environmental Conditions	Operating Temperature	0° to +45°C (32° to 113°F)			
	Storage Temperature	-20° to +70°C (-4° to 158°F)			
	Humidity	10% to 90%, RHL non-condensing			
Regulatory Compliance	Safety	CE, FCC			
	Environmental	RoHs, WEEE			
Enclosure	Size	Mega Tool Deep			
	Type	Aluminum			
	Cooling	Convection Ventilation			
Dimensions	Net Dimensions (W, D, H)	18.9cm x 14.5cm x 2.76cm (7.44" x 5.71" x 1.09")			
	Shipping Dimensions (W, D, H)	31.2cm x 17.9cm x 7.6cm (12.28" x 7.05" x 2.99")			
Weight	Net Weight	0.7kg (1.54lbs) approx.			
	Shipping Weight	0.9kg (2lbs) approx.			
Specifications are subject to change without notice at www.kramerav.com					

11.3 Default Communication Parameters

P3K		
Example (stop encoder decoder activity)	#KDS-ACTION 0<CR>	
Ethernet		
To reset the IP settings to the factory reset values go to: Menu->Setup -> Factory Reset-> press Enter to confirm		
	KDS-17EN	KDS-17DEC
DHCP	Default	Default
IP Address:	192.168.1.39	192.168.1.40
Subnet mask:	255.255.255.0	255.255.255.0
Default gateway:	192.168.1.254	192.168.1.254
TCP Port #:	5000	5000
UDP Port #:	50000	50000
Default username:	admin	admin
Default password:	admin	admin
Full Factory Reset		
Embedded web pages	Device Settings > General > RESET	
Front panel buttons	Press the RESET button on the rear panel for 10 seconds	

12 Protocol 3000

Kramer devices can be operated using Kramer Protocol 3000 commands sent via serial or Ethernet ports.

12.1 Understanding Protocol 3000

Protocol 3000 commands are a sequence of ASCII letters, structured according to the following.

- **Command format:**

Prefix	Command Name	Constant (Space)	Parameter(s)	Suffix
#	Command	_	Parameter	<CR>

- **Feedback format:**

Prefix	Device ID	Constant	Command Name	Parameter(s)	Suffix
~	nn	@	Command	Parameter	<CR><LF>

- **Command parameters** – Multiple parameters must be separated by a comma (,). In addition, multiple parameters can be grouped as a single parameter using brackets ([and]).
- **Parameters attributes** – Parameters may contain multiple attributes. Attributes are indicated with pointy brackets (<...>) and must be separated by a period (.).

The command framing varies according to how you interface with **KDS-17EN**. The following figure displays how the # command is framed using terminal communication software (such as Hercules):

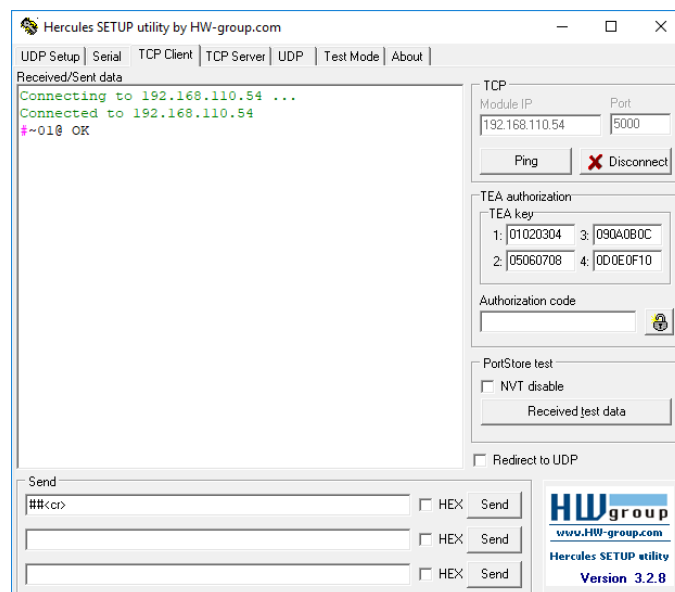

12.2 Protocol 3000 Commands

Function	Description	Syntax	Response	Parameters/Attributes	Example
#	Protocol handshaking. NOTE: Validates the Protocol 3000 connection and gets the machine number. Step-in master products use this command to identify the availability of a device.	#<CR>	~nn@_OK<CR><LF>		#<CR>
BUILD-DATE?	Get device build date	#BUILD-DATE?<CR>	~nn@BUILD-DATE_date,time<CR><LF>	date – Format: YYYY/MM/DD where YYYY = Year MM = Month DD = Day time – Format: hh:mm:ss where hh = hours mm = minutes ss = seconds	Get the device build date: #BUILD-DATE?<CR>
CD-CONVERT	Set the Color Depth convert mode.	#CD-CONVERT out_index,cd_mode<CR>	~nn@CD-CONVERT out_index,cd_mode<CR><LF>	out_index – Number that indicates the specific output: 1-N (N= the total number of outputs) cd_mode – Index in resolution table: 0 – Follow Output (default) 1 – Force 8 bit	Enable 'force 8 bit' mode for channel 1: #CD-CONVERT_1,1<CR>
CD-CONVERT?	Get the Color Depth convert mode.	#CD-CONVERT? out_index<CR>	~nn@CD-CONVERT? out_index,cd_mode<CR><LF>	out_index – Number that indicates the specific output: 1-N (N= the total number of outputs) cd_mode – Index in resolution table: 0 – Follow Output (default) 1 – Force 8 bit	Get the color depth convert mode status for channel 1: #CD-CONVERT_1,1<CR>
CEC-GW-PORT-ACTIVE	Set CEC Gateway mode - Whether CEC commands coming from HDMI stream to LAN	#CEC-GW-PORT-ACTIVE_gw_mode<CR>	~nn@CEC-GW-PORT-ACTIVE_gw_mode<CR><LF>	gw_mode: 0 – CEC Passthrough mode 1 – CEC Gateway mode – command to be sent to HDMI Input. 2 – CEC Gateway mode – command to be sent to HDMI Output. (KDS-DEC7 & WP-DEC7) 3 – CEC Gateway mode – command to be sent to HDMI Loop Through (KDS-EN7, KDS-SW2-EN7)	Set CEC Gateway mode: #CEC-GW-PORT-ACTIVE_1<CR>
CEC-GW-PORT-ACTIVE?	Get CEC Gateway mode - Whether CEC commands coming from HDMI stream to LAN	#CEC-GW-PORT-ACTIVE?<CR>	~nn@CEC-GW-PORT-ACTIVE_gw_mode<CR><LF>	gw_mode: 0 – CEC Passthrough mode 1 – CEC Gateway mode – command to be sent to HDMI Input. 2 – CEC Gateway mode – command to be sent to HDMI Output. (KDS-DEC7 & WP-DEC7) 3 – CEC Gateway mode – command to be sent to HDMI Loop Through (KDS-EN7, KDS-SW2-EN7)	Get CEC Gateway mode: #CEC-GW-PORT-ACTIVE?<CR>
CEC-MEMBERS?	Get list of CEC logical addresses.	#CEC-MEMBERS? port_index<CR>	~nn@CEC-MEMBERS? port_index,<la1>,<la2>...<CR><LF>	Port_index – 1 la – 1 to 15	Get gateway members: #CEC-MEMBERS? 1<CR>
CEC-NTFY	Notify about CEC command retrieved from bus. NOTE: Notification is sent to all com ports upon CEC message retrieval from CEC bus	N/A	~nn@CEC-NTFY port_index,len,<cec_command...><CR><LF>	port_index – CEC port notifying the command len – 1-16 cec_command – CEC format command (in HEX format, no leading zeros, no '0x' prefix)	Notify about CEC command retrieved from bus.: ~01@CEC-NTFY_2,0F36<CR>
CEC-NTFY-MODE	Set CEC notify work mode. NOTE: When disabled, no CEC messages retrieved from the CEC bus will be reported to connected P3K clients.	#CEC-NTFY-MODE mode<CR>	~nn@CEC-NTFY-MODE mode<CR><LF>	mode: 1 – Enable notifications (DEFAULT) 0 – Disable notifications	Disable the CEC-NTFY report: #CEC-NTFY-MODE_0<CR>
CEC-NTFY-MODE?	Get CEC notify work mode. NOTE: When disabled, no CEC messages retrieved from the CEC bus will be reported to connected P3K clients.	#CEC-NTFY-MODE?<CR>	~nn@CEC-NTFY-MODE mode<CR><LF>	mode: 1 – Notifications enabled (DEFAULT) 0 – Notifications disabled	Get the CEC-NTFY-MODE: #CEC-NTFY-MODE?<CR>

Function	Description	Syntax	Response	Parameters/Attributes	Example
CEC-SND	Send CEC command to port.	#CEC-SND <u>port_index</u> ,sn_id,cmd_name,cec_len,cec_command<CR>	~nn@CEC-SND <u>port_index</u> ,sn_id,cmd_name,cec_mode<CR><LF>	port_index – CEC port transmitting the command (1 – number of ports) sn_id – serial number of command for flow control and response commands from device cmd_name – command name cec_len – 1–16 cec_command – CEC format command (in HEX format, no leading zeros, no '0x' prefix) cec_mode – CEC mode 0 – Sent (Only support Sent, other error feedback with common P3K error code)	Send CEC command to port: #CEC-SND <u>1,1,1,2,E004</u> <CR>
COM-ROUTE?	Get communication route tunnel connection state	#COM-ROUTE? <u>com_id</u> <CR>	~nn@COM-ROUTE <u>com_id</u> ,port_type,port_id,eth_rep_en,timeout<CR><LF>	com_id – Machine dependent (number of ports, only 1 accepted), * (get all route tunnels) port_type – TCP/UDP 0 – TCP 1 – UDP port_id – TCP/UDP port number eth_rep_en – Ethernet Reply 0 – COM port does not send replies to new clients 1 – COM port sends replies to new clients. timeout – Keep alive timeout in seconds (1 to 3600)	Get tunneling port routing for all route tunnels: #COM-ROUTE? <u>1</u> *<CR>
COM-ROUTE-ADD	Add a communication route tunnel connection	#COM-ROUTE-ADD <u>com_id</u> ,port_type,port_id,eth_rep_en,timeout<CR>	~nn@COM-ROUTE-ADD <u>com_id</u> ,port_type,port_id,eth_rep_en,timeout<CR><LF>	com_id – Machine dependent (number of ports, only 1 accepted) port_type – TCP/UDP 0 – TCP port_id – port number (5000 to 5999) eth_rep_en – Ethernet Reply 0 – COM port does not send replies to new clients 1 – COM port sends replies to new clients. timeout – Keep alive timeout in seconds (1 to 3600)	Add a communication route tunnel connection: #COM-ROUTE-ADD <u>1,0,5001,1,1</u> <CR>
COM-ROUTE-REMOVE	Remove a communication route tunnel connection.	#COM-ROUTE-REMOVE <u>com_id</u> <CR>	~nn@COM-ROUTE-REMOVE <u>com_id</u> <CR><LF>	com_id – Machine dependent (number of ports, only 1 accepted)	Remove a communication route tunnel connection: #COM-ROUTE-REMOVE <u>1</u> <CR>
CS-CONVERT	Set the "force RGB color space" convert mode. For KDS-17DEC	#CS-CONVERT <u>out_index</u> ,cs_mode<CR>	~nn@CS-CONVERT <u>out_index</u> ,cs_mode<CR><LF>	out_index – Number that indicates the specific output: 1-N (N= the total number of outputs) cs_mode – Index in resolution table: 0 – Color space pass (default) 1 – Enable "force RGB color space" convert mode	Enable "force RGB color space" convert mode for channel 1: #CS-CONVERT <u>1,1</u> <CR>
CS-CONVERT?	Get the "force RGB color space" convert mode. For KDS-17DEC	#CS-CONVERT? <u>out_index</u> <CR>	~nn@CS-CONVERT <u>out_index</u> ,cs_mode<CR><LF>	out_index – Number that indicates the specific output: 1-N (N= the total number of outputs) cs_mode – Index in resolution table: 0 – Color space pass (default) 1 – Enable "force RGB color space" convert mode	Get the "force RGB color space" convert mode status for channel 1: #CS-CONVERT? <u>1</u> <CR>
EDID-MODE	Set EDID work mode. For KDS-17EN	#EDID-MODE <u>Input_id</u> ,Mode,Index<CR>	~nn@EDID-MODE <u>Input_id</u> ,Mode,Index<CR><LF>	Input_id – 1 Mode – - PASSTHRU (get from decoder) - CUSTOM - DEFAULT Index – CUSTOM should have an 'index' from which get from 'EDID-LIST?'	Set EDID to custom mode, idx is 1 #EDID-MODE <u>1,CUSTOM,1</u> <CR>
EDID-MODE?	Get EDID work mode For KDS-17EN	#EDID-MODE? <u>Input_id</u> <CR>	~nn@EDID-MODE <u>Input_id</u> ,Mode,Index<CR><LF>	Input_id – 1 Mode – - PASSTHRU (get from decoder) - CUSTOM - DEFAULT Index – CUSTOM should have an 'index' from which get from 'EDID-LIST?'	Get EDID Mode #EDID-MODE? <u>1</u> <CR>
ETH-PORT	Set Ethernet port protocol. NOTE: If the port number you enter is already in use, an error is returned. The port number must be within the following range: 0-(2 ¹⁶ -1).	#ETH-PORT <u>port_type</u> ,port_id<CR>	~nn@ETH-PORT <u>port_type</u> ,port_id<CR><LF>	port_type – - TCP - UDP port_id – when port_type = TCP: 5000–5099 when port_type = UDP: 50000–50999	Set the Ethernet port protocol for TCP to port 5000: #ETH-PORT <u>TCP,5000</u> <CR>

Function	Description	Syntax	Response	Parameters/Attributes	Example
ETH-PORT?	Get Ethernet port protocol.	#ETH-PORT?_port_type<CR>	~nn@ETH-PORT_ port_type ,port_id<CR><LF>	port_type – - TCP - UDP port_id – when port_type = TCP: 5000-5099 when port_type = UDP: 50000-50999	Get the Ethernet port protocol for TCP: #ETH-PORT?_TCP<CR>
ETH-TUNNEL?	Get an open tunnel parameters.	#ETH-TUNNEL?_tunnel_id<CR>	~nn@ETH-TUNNEL_ [[tunnel_id,com_id,port_type,port_id,eth_ip,remote_port_id,eth_rep_en,connection_type],...]<CR><LF>	tunnel_id – Tunnel ID number, * (get all open tunnels) com_id – Machine dependent 1 – First COM Port port_type – TCP/UDP 0 – TCP port_id – TCP/UDP port number eth_ip – Client IP address remote_port_id – Remote port number eth_rep_en – Ethernet Reply 0 – COM port does not send replies to new clients 1 – COM port sends replies to new clients connection_type – Connection type 1 – wired connection	Get all open tunnel parameters: #ETH-TUNNEL?_*<CR>
FACTORY	Reset device to factory default configuration NOTE: This command deletes all user data from the device. The deletion can take some time. Your device may require powering off and powering on for the changes to take effect.	#FACTORY<CR>	~nn@FACTORY_ ok<CR><LF>		Reset the device to factory default configuration: #FACTORY<CR>
GET-MGR-IP?	Get AVoIP Manager IP	#GET-MGR-IP?<CR>	~nn@GET-MGR-IP mgrip<CR><LF>	mgrip: AVoIP Manager IP 0.0.0.0 – means AVoIP Manager not IP enabled.	Get MGR-IP: #GET-MGR-IP?<CR>
GTW-MSG-CLEAR	Clear Control Gateway Messages Counter.	#GTW-MSG-CLEAR message_type<CR>	~nn@GTW-MSG-NUM message_type<CR><LF>	message_type - where 0 = ALL 1 = CEC 2 = IR 3 = RS232	Clear all Control Gateway Messages Counter #GTW-MSG-CLEAR 0<CR>
GTW-MSG-NUM?	Get Control Gateway Messages Counter from the device boot done. Add Recv_Count and Send_Count NOTE: <date> is legacy parameter, for KDS7 always be ignored	#GTW-MSG-NUM?_message_type,date<CR>	~nn@GTW-MSG-NUM_ message_type,date,recv_counter,send_count<CR><LF>	message_type – where 1 =CEC 2 = IR 3 = RS232 date – Format: DD-MM-YYYY. Recv_counter – counter of receive messages Send_counter – counter of send messages	Get Control Gateway Messages Counter from certain period: #GTW-MSG-NUM?_1,01-01-1970<CR>
HDCP-MOD	Set HDCP mode. NOTE: Set HDCP working mode on the device input. HDCP supported - HDCP_ON [default]. HDCP not supported - HDCP OFF. For KDS-17EN	#HDCP-MOD_ in_index,mode<CR>	~nn@HDCP-MOD_ in_index, mode<CR><LF>	in_index – Number that indicates the specific input: 1-N (N= the total number of inputs) mode – HDCP mode: 0 – HDCP Off 1 – HDCP On	Set the input HDCP-MODE of IN 1 to Off: #HDCP-MOD_1,0<CR>
HDCP-MOD?	Get HDCP mode. NOTE: Set HDCP working mode on the device input. HDCP supported - HDCP_ON [default]. HDCP not supported - HDCP OFF. HDCP support changes following detected sink - MIRROR OUTPUT. For KDS-17EN	#HDCP-MOD?_ in_index<CR>	~nn@HDCP-MOD_ in_index, mode<CR><LF>	in_index – Number that indicates the specific input: 1-N (N= the total number of inputs) mode – HDCP mode: 0 – HDCP Off 1 – HDCP On 3 – HDCP Mirror Mode - used by KDS-7 decoder to allow an HDCP 2.2 source connected to the encoder to play on an HDCP 1.4 TV/display connected to the decoder.	Get the input HDCP-MODE of IN 1 HDMI: #HDCP-MOD_<CR>
HDCP-OUT	Set the output port's HDCP mode.	#HDCP-OUT in_index,mode<CR>	~nn@HDCP-OUT in_index,mode<CR><LF>	in_index – Number that indicates the specific output: 1-N (N= the total number of inputs) mode – HDCP mode: 0 – HDCP follows input 1 – HDCP follows output (default)	Set the output HDCP-OUT of OUT 1 to follow source: #HDCP-OUT 1,0<CR>
HDCP-OUT?	Get the output port's HDCP mode.	#HDCP-OUT? in_index<CR>	~nn@HDCP-OUT in_index,mode<CR><LF>	in_index – Number that indicates the specific output: 1-N (N= the total number of inputs) mode – HDCP mode: 0 – HDCP follows input 1 – HDCP follows output	Get the HDCP mode of output 1: #HDCP-OUT? 1<CR>

Function	Description	Syntax	Response	Parameters/Attributes	Example
HDCP-STAT?	Get HDCP signal status. NOTE: io_mode =1 – get the HDCP signal status of the sink device connected to the specified output. io_mode =0 – get the HDCP signal status of the source device connected to the specified input.	#HDCP-STAT? <u>io_mode</u> ,in_index<CR>	~nn@HDCP-STAT <u>io_mode</u> ,in_index,status<CR><LF>	io_mode – Input/Output 0 – Input 1 – Output io_index – Number that indicates the specific number of inputs or outputs (based on io_mode): 1-N (N=total number of inputs or outputs) status – Signal encryption status - valid values On/Off 0 – HDCP Off 1 – HDCP On	Get the output HDCP-STATUS of IN 1: #HDCP-STAT? <u>0</u> ,1<CR>
HELP	Get command list or help for specific command.	#HELP <CR>	1. Multi-line: ~nn@Device <u>cmd_name</u> , cmd_name<CR><LF>	cmd_name – Name of a specific command	Get the command list: #HELP <CR>
HTTP-AUTH-ENABLE	Start/stop HTTP/HTTPS communication security. NOTE: The HTTP/HTTPS permission works only if security is enabled with the "HTTP-AUTH-ENABLE" command.	#HTTP-AUTH-ENABLE <u>security_state</u> ,password<CR>	~nn@HTTP-AUTH-ENABLE <u>security_state</u> <CR><LF>	security_state – Security state 0 – OFF (disables security) 1 – ON (enables security) password – password in unicode64 format, only if the password is valid, AUTH will be disabled otherwise reject the request. NOTE: It is only required when the security_state is 0 for disabling the security.	Enable the permission system: #HTTP-AUTH-ENABLE <u>0</u> ,dGVZdA==<CR>
HTTP-AUTH-ENABLE?	Get HTTP/HTTPS security state.	#HTTP-AUTH-ENABLE? <CR>	~nn@HTTP-AUTH-ENABLE <u>security_state</u> <CR><LF>	security_state – Security state 0 – OFF (disables security) 1 – ON (enables security)	Get security state: #HTTP-AUTH-ENABLE? <CR>
HTTP-LOGOUT-TIMEOUT	Set HTTP inactivity auto-logout time.	#LOGOUT-TIMEOUT time<CR>	~nn@LOGOUT-TIMEOUT time<CR><LF>	time – minutes of logout time 0-60	Set Inactivity auto-logout time to 10 #LOGOUT-TIMEOUT 10<CR>
HTTP-LOGOUT-TIMEOUT?	Get HTTP inactivity auto-logout time.	#LOGOUT-TIMEOUT? <CR>	~nn@LOGOUT-TIMEOUT time<CR><LF>	time – minutes of logout time 0~60	Get Inactivity auto-logout time #LOGOUT-TIMEOUT? <CR>
HTTP-PASSWD	Set password for HTTP user login. The default password is "admin".	#HTTP-PASSWD <u>user</u> ,password<CR>	~nn@HTTP-PASSWD <u>user</u> ,password<CR><LF>	user – user name of login to set (admin support only). password – Password for the user, in unicode64 format. 8 to 24 characters (letters, numbers, and symbols without spaces or commas), at least including one number, one symbols without spaces or commas, one uppercase letter and one lowercase letter.	Set the password for the admin protocol permission level to 'Aa12345!': #HTTP-PASSWD <u>admin</u> ,QWExMjM0NSE=<CR>
HW-TEMP?	Get device heat	#HW-TEMP? <u>region_id</u> ,mode<CR>	~nn@HW-TEMP <u>region_id</u> ,temperature<CR><LF>	region_id – ID of the region for which to get the temperature 0 – Region 0 mode – Celsius or Fahrenheit 0 – Celsius 1 – Fahrenheit temperature – Temperature of the HW region, rounded down to the closest integer	Get temperature in Celsius of first cpu #HW-TEMP? <u>0</u> ,0<CR>
HW-VERSION?	Get hardware version	#HW-VERSION? <CR>	~nn@HW-VERSION <u>hardware_version</u> <CR><LF>	hardware_version – XX.XX.XXXX where the digit groups are: major.minor.version	Get hardware version #HW-VERSION? <CR>
IDV	Set visual indication from device. NOTE: Using this command, some devices can light a sequence of buttons or LEDs to allow identification of a specific device from similar devices.	#IDV <CR>	~nn@IDV <u>ok</u> <CR><LF>		#IDV <CR>
IR-LEARN	Receive IR command from port.	#IRLEARN <CR>	~nn@IRLEARN ir_status,<pronto-command><CR><LF>	pronto_command – Pronto format command (in HEX format, no leading zeros, no '0x' prefix, with comma separated) ir_status – IR Status 0 – Done 1 – Busy 2 – Wrong Parameter 3 – Timeout 4 – Error	Get TVON IR code: #IRLEARN <CR>

Function	Description	Syntax	Response	Parameters/Attributes	Example
KDS-CHANNEL-SELECT	Set decoder AV or IR channel. Add signal_type. For KDS-17DEC	#KDS-CHANNEL- SELECT <u>[signal_type_1,signal_type_2,...],ch_id<CR></u>	~nn@KDS-CHANNEL- SELECT <u>[signal_type_1,signal_type_2,...],ch_id<CR><LF></u>	<signal_type> – Signal ID attribute: VIDEO AUDIO IR RS232 USB CEC ch_id – Number that indicates the specific input 0-999. 0 is for cancel the channel select.	Tune the decoder to ch_id 1 #KDS-CHANNEL- SELECT <u>[video,audio,rs232,ir,usb,cec],1<CR></u>
KDS-CHANNEL-SELECT?	Get decoder AV or IR channel. Add signal_type. For KDS-17DEC	#KDS-CHANNEL- SELECT? <u>signal_type<CR></u>	~nn@KDS-CHANNEL- SELECT <u>signal_type,ch_id<CR><LF></u>	<signal_type> – Signal ID attribute: VIDEO AUDIO IR RS232 USB CEC ch_id – Number that indicates the specific input 0-999. 0 is for cancel the channel select.	Get channel ID #KDS-CHANNEL- SELECT? <u>video<CR></u>
KDS-DEFINE-CHANNEL	Set Encoder AV channel ID. For KDS-17EN	#KDS-DEFINE- CHANNEL <u>ch_id<CR></u>	~nn@KDS-DEFINE- CHANNEL <u>ch_id<CR><LF></u>	ch_id – Number that indicates the specific input 1-999.	Tune the encoder: #KDS-DEFINE- CHANNEL <u>1<CR></u>
KDS-DEFINE-CHANNEL?	Get Encoder AV channel ID. For KDS-17EN	#KDS-DEFINE-CHANNEL? <u><CR></u>	~nn@KDS-DEFINE- CHANNEL <u>ch_id<CR><LF></u>	ch_id – Number that indicates the specific input 1-999.	Get channel ID: #KDS-DEFINE- CHANNEL? <u><CR></u>
KDS-ETH-BRIDGE	Set KDS17 Ethernet bridge mode	#KDS-ETH-BRIDGE mode,idx,vlanid<CR>	~nn@KDS-ETH-BRIDGE mode,idx,vlanid<CR><LF>	mode: 0 - Disable 1 - Enable idx: interface inde 0 - LAN 1 1 - LAN 2 vlanid: 0-4000	Set bridge mode to LAN2 #KDS-ETH-BRIDGE 1,2,1 <u><CR></u>
KDS-ETH-BRIDGE?	Get KDS17 Ethernet bridge mode	#KDS-ETH-BRIDGE? <u><CR></u>	~nn@KDS-ETH-BRIDGE mode,idx,vlanid<CR><LF>	mode: 0 - Disable 1 - Enable idx: interface inde 0 - LAN 1 1 - LAN 2 vlanid: 1-4000	Get bridge mode #KDS-ETH-BRIDGE? <u><CR></u>
KDS-METHOD	Set unicast / multicast.	#KDS-METHOD <u>1<CR></u>	~nn@KDS-METHOD <u>method<CR><LF></u>	method – Streaming method 1 Unicast 2 Multicast	Set current streaming method of encoder/decoder: #KDS-METHOD <u>1<CR></u>
KDS-METHOD?	Get unicast / multicast.	#KDS-METHOD? <u><CR></u>	~nn@KDS-METHOD <u>method<CR><LF></u>	method – Streaming method 1 – Unicast 2 – Multicast	Get current streaming method of encoder/decoder: #KDS-METHOD <u><CR></u>
KDS-MULTICAST	Set multicast group address and TTL value.	#KDS- MULTICAST <u>group_ip,ttl<CR></u>	~nn@KDS- MULTICAST <u>group_ip,ttl<CR><LF></u>	group-ip – Multicast group IP for KDS7 is ignored, KDS7 managed multicast address automatically. ttl – Time to Live of the streamed packets.	Set multicast group address and TTL value: #KDS-MULTICAST 0.0.0.0,64 <u><CR></u>
KDS-MULTICAST?	Get multicast group address and TTL value.	#KDS-MULTICAST? <u><CR></u>	~nn@KDS- MULTICAST <u>group_ip,ttl<CR><LF></u>	group-ip – Multicast group IP for KDS7 is ignored, KDS7 managed multicast address automatically, so always response 0.0.0.0 ttl – Time to Live of the streamed packets.	Get multicast group address and TTL value: #KDS-MULTICAST? <u><CR></u>
KDS-MULTICAST-PREFIX	Set prefix of multicast group address.	#KDS-MULTICAST- PREFIX <u>prefix<CR></u>	~nn@KDS-MULTICAST- PREFIX <u>prefix<CR><LF></u>	prefix – Prefix of multicast group IP for KDS7 224-239	Set multicast group address and TTL value: #KDS-MULTICAST-PREFIX 224 <u><CR></u>
KDS-MULTICAST-PREFIX?	Get prefix of multicast group address.	#KDS-MULTICAST-PREFIX? <u><CR></u>	~nn@KDS-MULTICAST- PREFIX <u>prefix<CR><LF></u>	prefix – Prefix of multicast group IP for KDS7	Get multicast group address and TTL value: #KDS-MULTICAST- PREFIX? <u><CR></u>
KDS-OSD-DISPLAY	Set decoder Display Device Information On/Off For KDS-17DEC	#KDS-OSD-DISPLAY <u>mode<CR></u>	~nn@KDS-OSD- DISPLAY <u>mode<CR><LF></u>	mode – 0 - off 1 - on 2 - display now + on	Set OSD Display mode on: #KDS-OSD- DISPLAY <u>1<CR></u>
KDS-OSD-DISPLAY?	Get decoder Display Device Information status For KDS-17DEC	#KDS-OSD-DISPLAY? <u><CR></u>	~nn@KDS-OSD- DISPLAY <u>mode<CR><LF></u>	mode – 0 - off 1 - on 2 - display now + on	Get OSD display mode: #KDS-OSD-DISPLAY? <u><CR></u>
KDS-OSD-HOTKEY	Set decoder OSD hotkey. For KDS-17DEC	#KDS-OSD-HOTKEY <u>mode<CR></u>	~nn@KDS-OSD- HOTKEY <u>mode<CR><LF></u>	mode – 0 - CAP 1 - CTL 2 - TAB 3 - SHIFT	Set OSD hotkey to CTL: #KDS-OSD- HOTKEY <u>1<CR></u>
KDS-OSD-HOTKEY?	Get decoder OSD hotkey. For KDS-17DEC	#KDS-OSD-HOTKEY? <u><CR></u>	~nn@KDS-OSD- HOTKEY <u>mode<CR><LF></u>	mode – 0 - CAP 1 - CTL 2 - TAB 3 - SHIFT	Get OSD hotkey mode: #KDS-OSD-HOTKEY? <u><CR></u>

Function	Description	Syntax	Response	Parameters/Attributes	Example
KDS-PREVIEW	Set preview parameters. NOTE: When PREVIEW is OFF, other parameters should not be provided	#KDS-PREVIEW mode, width, height, fps, bw, a s, mq<CR>	~nn@KDS-PREVIEW mode, width, height, fps, b w, as, mq<CR>	mode: 0 - OFF 1 - ON width: 0-1280 pixels height: 0-720 pixels fps: 1-60 frames per second bw: 1-50000 Kbps as: 0 - Do not need keep ratio 1 - Keep ratio mq: 60-100	Set preview on with 960x540@10Hz, 8Mbps, keep ratio. #KDS-PREVIEW 1,960,5640,15,8000,0,60<CR> >
KDS-PREVIEW?	Get preview parameters. NOTE: When PREVIEW is OFF, other parameters STILL need be responded.	#KDS-PREVIEW?<CR>	~nn@KDS-PREVIEW mode, width, height, fps, b w, as, mq<CR>	mode: 0 - OFF 1 - ON width: 0-1280 pixels height: 0-720 pixels fps: 1-60 frames per second bw: 1-50000 Kbps as: 0 - Do not need keep ratio 1 - Keep ratio mq: 60-100	Get preview parameters. #KDS-PREVIEW?<CR>
KDS-RATIO?	Get aspect ratio.	#KDS-RATIO?<CR>	~nn@KDS- RATIO, value<CR><LF>	value – Streamer Decoder Aspect Ratio width: height, for example "16:9"	Get Aspect Ratio: #KDS-RATIO?<CR>
KDS-RESOL?	Get actual AV stream resolution.	#KDS- RESOL?, io_mode, io_index, is _native<CR>	~nn@KDS- RESOL?, io_mode, io_inde x, is_native, resolution< CR><LF>	io_mode – Input/Output 0 - Input 1 - Output io_index – Number that indicates the specific input or output port: 1-N (N= the total number of input or output ports) is_native – Native resolution flag 0 - Off 1 - On resolution – Resolution index 0-3 = (Reserved) 4=1280x720p@59.94Hz/60Hz 5-15=(Reserved) 16=1920x1080p@59.94Hz/60Hz 17-30=(Reserved) 31=1920x1080p@50Hz 32-65=(Reserved) 66=1024x768@60Hz 67=1280x768p@60Hz 68=1280x1024p@60Hz 69=1600x1200p@60Hz 70=1680x1050p@60Hz 71=1920x1200@60Hz 72=3840x2160p@24Hz 73=3840x2160p@25Hz 74=3840x2160p@30Hz 75=3840x2160p@50Hz 76=3840x2160p@60Hz 77-1030=(Reserved) 1031=1360x768p@60Hz 1032-1038=(Reserved) 1039=600x900p@60Hz 1040-9999=(Reserved)	
KDS-SCALE	Set scaling mode Add res_type. For KDS-17DEC	#KDS- SCALE, value, res_type<CR>	~nn@KDS- SCALE, value, res_type<C R><LF>	value – Streamer Decoder Scaling Mode 0 - Pass Thru 1 - Scaling 2 - Based on EDID res_type[option] –Resolution index 0-3=(Reserved) 4=1280x720p@59.94Hz/60Hz 5-15=(Reserved) 16=1920x1080p@59.94Hz/60Hz 17-30=(Reserved) 31=1920x1080p@50Hz 32-65=(Reserved) 66=1024x768@60Hz 67=1280x768p@60Hz 68=1280x1024p@60Hz 69=(Reserved) 70=1680x1050@60 71=1920x1200@60 72=(Reserved) 73=3840x2160p@25Hz 74=3840x2160p@30Hz 75-1030=(Reserved) 1031=1360x768p@60Hz 1032-1038=(Reserved) 1039=1600x900p@60Hz 1040-9999=(Reserved)	Set scale to scaling, resolution is 1080P60: #KDS-SCALE, 1,16<CR>

Function	Description	Syntax	Response	Parameters/Attributes	Example												
KDS-SCALE?	Get scaling mode Add res_type. For KDS-17DEC	#KDS-SCALE?<CR>	~nn@KDS-SCALE_ value,res_type<CR><LF>	value – Streamer Decoder Scaling Mode 0 - Pass Thru 1 - Scaling 2 - Based on EDID res_type[option] – res_type refer to #KDS-SCALE	Get scaling mode: #KDS-SCALE?<CR>												
KDS-SLEEP-IMAGE	Set sleep image mode of decoder. For KDS-17DEC	#KDS-SLEEP-IMAGE_ mode<CR>	~nn@KDS-SLEEP-IMAGE_ mode<CR><LF>	mode – sleep image mode for decoder 0 - Off 1 - On	Stop the Sleep Image: #KDS-SLEEP-IMAGE 0<CR>												
KDS-SLEEP-IMAGE?	Get sleep image mode of decoder. For KDS-17DEC	#KDS-SLEEP-IMAGE?<CR>	~nn@KDS-SLEEP-IMAGE_ mode<CR><LF>	mode – sleep image mode for decoder 0 - Off 1 - On	Get the Sleep Image mode: #KDS-SLEEP-IMAGE?<CR>												
KDS-VW-MONITOR	Set Video Wall bezel compensation. For KDS-17DEC	#KDS-VW-MONITOR _mon_w,mon_h,b_top,b_bottom,b_left,b_right<CR>	~nn@KDS-VW-MONITOR _mon_w,mon_h,b_top,b_bottom,b_left,b_right<CR><LF>	mon_w – monitor out width, 0~10000mm mon_h – monitor height, 0~10000mm b_top – bezel top, 0~10000mm b_bottom – bezel bottom, 0~10000mm b_left – bezel left, 0~10000mm b_right – bezel right, 0~10000mm	Set video wall monitor info #KDS-VW-MONITOR 12210,12310,6860,6960<CR>												
KDS-VW-MONITOR?	Get Video Wall bezel compensation. For KDS-17DEC	#KDS-VW-MONITOR?<CR>	~nn@KDS-VW-MONITOR _mon_w,mon_h,b_top,b_bottom,b_left,b_right<CR><LF>	mon_w – monitor out width, 0~10000mm mon_h – monitor height, 0~10000mm b_top – bezel top, 0~10000mm b_bottom – bezel bottom, 0~10000mm b_left – bezel left, 0~10000mm b_right – bezel right, 0~10000mm	Get video wall monitor info #KDS-VW-MONITOR?<CR>												
KDS-VW-PATTERN	Set test pattern mode of video wall. For KDS-17DEC	#KDS-VW-PATTERN_ mode<CR>	~nn@KDS-VW-PATTERN_ mode<CR><LF>	Mode – 0 - OFF (Disable test pattern) 1 - On (Enable test pattern)	Set video wall test pattern on: #KDS-VW-PATTERN_1<CR>												
KDS-VW-PATTERN?	Get test pattern mode of video wall. For KDS-17DEC	#KDS-VW-PATTERN?<CR>	~nn@KDS-VW-PATTERN_ mode<CR><LF>	Mode – 0 - OFF (Disable test pattern) 1 - On (Enable test pattern)	Get video wall test pattern on: #KDS-VW-PATTERN?<CR>												
LDFW	Load new firmware file. NOTE: In most devices firmware data is saved to flash memory, but the memory does not update until receiving the "UPGRADE" command and is restarted.	Step 1: #LDFW_ size<CR> Step 2: If ready was received, send FIRMWARE_DATA	Response 1: ~nn@LDFW_ size ready<CR><LF> Response 2: ~nn@LDFW_ size_ ok<CR><LF>	size – Size of firmware data that is sent. firmware_data – HEX or KFW file in protocol packets Using the Packet Protocol Send a command: LDRV, LOAD, IROUT, LDEDID Receive Ready or ERR### If Ready: a. Send a packet, b. Receive OK on the last packet, c. Receive OK for the command. Packet structure: Packet ID (1, 2, 3...) (2 bytes in length) Length (data length + 2 for CRC) – (2 bytes in length) Data (data length -2 bytes) CRC – 2 bytes <table border="1" style="margin-left: 20px;"><tr><td>01</td><td>02</td><td>03</td><td>04</td><td>05</td><td></td></tr><tr><td>Packet ID</td><td>Length</td><td>Data</td><td>CRC</td><td></td><td></td></tr></table> Response: ~nnnn_ ok<CR><LF> (Where NNNN is the received packet ID in ASCII hex digits.)	01	02	03	04	05		Packet ID	Length	Data	CRC			
01	02	03	04	05													
Packet ID	Length	Data	CRC														
LOCK-EDID	Lock last read EDID. For KDS-17EN	#LOCK-EDID_ in_index,lock_mode<CR>	~nn@LOCK-EDID_ in_index,lock_mode<CR><LF>	in_index – 1 lock_mode – On/Off 0 - Off unlocks EDID. 1 - On locks EDID.	Lock the last read EDID from the HDMI In 1 input: #LOCK-EDID_1,1<CR>												
LOCK-EDID?	Get EDID lock state. For KDS-17EN	#LOCK-EDID?_ in_index<CR>	~nn@LOCK-EDID_ in_index,lock_mode<CR><LF>	in_index – 1 lock_mode – On/Off 0 - Off unlocks EDID. 1 - On locks EDID.	Get EDID lock state for Input 1: #LOCK-EDID? _1<CR>												
LOCK-FP	Lock the front panel. For KDS-17EN	#LOCK-FP_ lock/unlock<CR>	~nn@LOCK-FP_ lock/unlock<CR><LF>	Lock/Unlock – On/Off 0 - (Off) Unlocks Front Panel. 1 - (On) Locks Front Panel.	Unlock front panel: #LOCK-FP_0<CR>												
LOCK-FP?	Get the front panel lock state. For KDS-17EN	#LOCK-FP?<CR>	~nn@LOCK-FP_ lock/unlock<CR><LF>	Lock/Unlock – On/Off 0 - (Off) Unlocks Front Panel. 1 - (On) Locks Front Panel.	Get the front panel lock state: #LOCK-FP?<CR>												

Function	Description	Syntax	Response	Parameters/Attributes	Example
LOG-ACTION	Reset events log.	#LOG- ACTION _action,period<CR>	~nn@LOG- ACTION _action,period<CR><LF>	action – One of 1 - Start, start logging 2 - Pause, pause logging but keep log content 3 - Resume, resume the logging 4 - Reset, clear all current logs, keep logging period – Relevant for "start"(be ignored by KDS7 Devices) 1 - Keep current 2 - Daily 3 - Weekly (default)	Reset events log: #LOG-ACTION _4,1<CR>
LOG-ACTION?	Get log state.	#LOG-ACTION?<CR>	~nn@LOG- ACTION _action,period<CR><LF>	action – One of 1 - Start, start logging 2 - Pause, pause logging but keep log content 3 - Resume, resume the logging 4 - Reset, clear all current logs, keep logging period – Relevant for "start"(be ignored by KDS7 Devices) 1 - Keep current 2 - Daily 3 - Weekly (default)	Get log state: #LOG-ACTION?<CR>
LOGIN	Set protocol permission. NOTE: The permission system works only if security is enabled with the "SECUR" command. LOGIN allows the user to run commands with an End User or Administrator permission level. When the permission system is enabled, LOGIN enables running commands with the User or Administrator permission level When set, login must be performed upon each connection It is not mandatory to enable the permission system in order to use the device In each device, some connections allow logging in to different levels. Some do not work with security at all. Connection may logout after timeout.	#LOGIN _login_level,password<CR>	~nn@LOGIN _login_level,password_ok<CR><LF>	login_level – Level of permissions required (User or Admin, only 'admin' is acceptable on KDS7 devices). password – Predefined password (by PASS command). Default password is 'admin'	Set the protocol permission level to Admin (when the password defined in the PASS command is 33333): #LOGIN _admin,33333<CR>
LOGIN?	Get current protocol permission level. NOTE: The permission system works only if security is enabled with the "SECUR" command. For devices that support security, LOGIN allows the user to run commands with an End User or Administrator permission level. In each device, some connections allow logging in to different levels. Some do not work with security at all. Connection may logout after timeout.	#LOGIN?<CR>	~nn@LOGIN _login_level<CR><LF>	login_level – Level of permissions required (User or Admin, only 'admin' is acceptable on KDS7 devices)	Get current protocol permission level: #LOGIN?<CR>
LOGOUT	Cancel current permission level. NOTE: Logs out from End User or Administrator permission levels to Not Secure.	#LOGOUT<CR>	~nn@LOGOUT _ok<CR><LF>		#LOGOUT<CR>
LOGOUT-TIMEOUT	Set inactivity auto-logout time.	#LOGOUT-TIMEOUT _time<CR>	~nn@LOGOUT-TIMEOUT _time<CR><LF>	time – minutes of logout time	Set Inactivity auto-logout time to 10: #LOGOUT-TIMEOUT _10<CR>
LOGOUT-TIMEOUT?	Get inactivity auto-logout time.	#LOGOUT-TIMEOUT?<CR>	~nn@LOGOUT-TIMEOUT _time<CR><LF>	time – minutes of logout time	Get Inactivity auto-logout time: #LOGOUT-TIMEOUT?<CR>
LOG-SRV	Set log server.	#LOGSRV mode,log_server_ip,log_server_port<CR>	~nn@LOGSRV mode,log_server_ip,log_server_port<CR><LF>	mode – On/Off 0 – Off 1 – On log_server_ip – Log server IP address log_server_port – Log server port	Set log server with IP address of 128.138.140.44:5050: #LOG-SRV 1,128.138.140.44,5050<CR>
LOG-SRV?	Get log server.	#LOGSRV?<CR>	~nn@LOGSRV mode,log_server_ip,log_server_port<CR><LF>	mode – On/Off 0 – Off 1 – On log_server_ip – Log server IP address log_server_port – Log server port	Get log server: #LOG-SRV?<CR>

Function	Description	Syntax	Response	Parameters/Attributes	Example
MANAGER-ID	Set Manager ID	#MANAGER-ID token<CR>	~nn@MANAGER-ID token	token - the encrypted token	Set the AVoIP Manager that provisions the device #MANAGER-ID VALIDTOKEN?<CR>
MANAGER-ID?	Get Manager ID	#MANAGER-ID?<CR>	~nn@MANAGER-ID timestamp,manager-id	timestamp - provisioning timestamp seconds since 1970 manager-id - a valid UUID, or all 0 for non provision	Get the AVoIP Manager that provisions the device #MANAGER-ID VALIDTOKEN?<CR>
MNG-NET-CONFIG	Set a network configuration for application services.	#MNG-NET-CONFIG service_id,DHCP,net_IP, net_mask,gateway,dns, 802-1q_mode,vlan_id, cos,dscp<CR>	~nn@MNG-NET-CONFIG service_id,DHCP,net_IP, net_mask,gateway,dns, 802-1q_mode,vlan_id, cos,dscp<CR><LF>	service_id - ID of the service: 0 - Control 1 - Service 2 - Dante DHCP - 0 - Use static IP address 1 - Try to use DHCP, net_IP , net_mask , gateway and dns are not relevant for SET command and will be ignored. net_IP - Network IP net_mask - Network mask gateway - Network gateway dns - DNS address 802-1q_mode - enable 802.1Q 0 - Off, vlan_id cos dscp are irrelevant for SET command and will be ignored 1 - On vlan_id - 2~4000 cos - 0~7 dscp - 0~63	Set the device control service network: #MNG-NET-CONFIG 0,0,192.168.13.100,25 5.255.255.0,192.168.1 3.1,8.8.8.8,1,20,7,56 <CR>
MNG-NET-CONFIG?	Get the network configuration for application services.	#MNG-NET-CONFIG service_id,DHCP,net_IP, net_mask,gateway,dns, 802-1q_mode,vlan_id, cos,dscp<CR>	~nn@MNG-NET-CONFIG service_id,DHCP,net_IP, net_mask,gateway,dns, 802-1q_mode,vlan_id, cos,dscp<CR><LF>	service_id - ID of the service: 0 - Control 1 - Service 2 - Dante DHCP - 0 - Use static IP address 1 - Try to use DHCP, net_IP , net_mask , gateway and dns are not relevant for SET command and will be ignored. net_IP - Network IP net_mask - Network mask gateway - Network gateway dns - DNS address 802-1q_mode - enable 802.1Q 0 - Off, vlan_id cos dscp are irrelevant for SET command and will be ignored 1 - On vlan_id - 2~4000 cos - 0~7 dscp - 0~63	Get the network configuration for control service: #MNG-NET-CONFIG? 0<CR>
MODEL?	Get device model. NOTE: This command identifies equipment connected to KDS-17EN and notifies of identity changes to the connected equipment. The Matrix saves this data in memory to answer REMOTE-INFO requests.	#MODEL?<CR>	~nn@MODEL_model_name<CR><LF>	model_name - String of up to 24 printable ASCII chars	Get the device model: #MODEL?<CR>
NAME	Set machine or DANTE (DNS) name. NOTE: The machine name is not the same as the model name. The machine name is used to identify a specific machine or a network in use (with DNS feature on).	#NAME_interface_id,host_name<CR>	~nn@NAME_interface_id, host_name<CR><LF>	interface_id - 0 - machine name 1 - dante name - Only available on KDS-SW3-EN7 host_name - String of up to 24 alpha-numeric chars (can include hyphen, underscore, not at the beginning or end)	Set the machine DNS name of the device to room-442: #NAME_0,room-442<CR>
NAME?	Get machine or DANTE (DNS) name. NOTE: The machine name is not the same as the model name. The machine name is used to identify a specific machine or a network in use (with DNS feature on).	#NAME?_interface_id<CR>	~nn@NAME_interface_id, host_name<CR><LF>	interface_id - 0 - machine name 1 - dante name - Only available on KDS-SW3-EN7 host_name - String of up to 24 alpha-numeric chars (can include hyphen, not at the beginning or end)	Get the DNS name of the device: #NAME?_0<CR>
NAME-RST	Reset machine (DNS) name to factory default. NOTE: Factory default of machine (DNS) name is "KRAMER_" + 4 last digits of device serial number.	#NAME-RST<CR>	~nn@NAME- RST_OK<CR><LF>		Reset the machine name (S/N last digits are 0102): #NAME-RST<CR>

Function	Description	Syntax	Response	Parameters/Attributes	Example
NET-CONFIG	Set a network configuration. NOTE: For Backward compatibility, the id parameter can be omitted. In this case, the Network ID, by default, is 0, which is the Ethernet control port. NOTE: If the gateway address is not compliant to the subnet mask used for the host IP, the command will return an error. Subnet and gateway compliance specified by RFC950. NOTE: This set the device to DHCP OFF automatically.	#NET-CONFIG _netw_id,net_ip ,net_mask,gateway<CR>	~nn@NET-CONFIG _netw_id ,net_ip,net_mask,gatewa y<CR><LF>	netw_id – Network ID–ID of the Ethernet port: 0 - Media Port 1 - Service Port 2 - DANTE Port net_ip – Network IP net_mask – Network mask gateway – Network gateway	Set the device network parameters to IP address 192.168.113.10, net mask 255.255.0.0, and gateway 192.168.0.1: #NET-CONFIG _0,192.168.1 13.10,255.255.0.0,192.168.0. 1<CR>
NET-CONFIG?	Get a network configuration.	#NET-CONFIG? _netw_id<CR>	~nn@NET-CONFIG _netw_id ,net_ip,net_mask,gatewa y<CR><LF>	netw_id – Network ID–ID of the Ethernet port: 0 - Media Port 1 - Service Port 2 - DANTE Port net_ip – Network IP net_mask – Network mask gateway – Network gateway	Get network configuration: #NET-CONFIG? _0<CR>
NET-DHCP	Set DHCP mode. NOTE: Only 1 is relevant for the mode value. To disable DHCP, the user must configure a static IP address for the device. Connecting Ethernet to devices with DHCP may take more time in some networks. To connect with a randomly assigned IP by DHCP, specify the device DNS name (if available) using the NAME command. You can also get an assigned IP by direct connection to USB or RS-232 protocol port, if available. For proper settings consult your network administrator. NOTE: For Backward compatibility, the id parameter can be omitted. In this case, the Network ID, by default, is 0, which is the Ethernet control port.	#NET-DHCP _netw_id,dhcp_sta te<CR>	~nn@NET-DHCP _netw_id,d hcp_state<CR><LF>	netw_id –Network ID–ID of the Ethernet port: 0 - Media Port 1 - Service Port 2 - DANTE Port dhcp_state – 1 - Try to use DHCP. (If unavailable, use the IP address set by the factory or the net-ip command).	Enable DHCP mode for port 1, if available: #NET-DHCP _1,1<CR>
NET-DHCP?	Get DHCP mode NOTE: For Backward compatibility, the id parameter can be omitted. In this case, the Network ID, by default, is 0, which is the Ethernet control port.	#NET-DHCP? _netw_id<CR>	~nn@NET-DHCP _netw_id,d hcp_state<CR><LF>	netw_id –Network ID–ID of the Ethernet port: 0 - Media Port 1 - Service Port 2 - DANTE Port dhcp_state – 1 - Try to use DHCP. (If unavailable, use the IP address set by the factory or the net-ip command).	Get DHCP mode for port 1, if available: #NET-DHCP? _1<CR>
NET-GATE?	Get the gateway IP	#NET-GATE?<CR>	~nn@NET-GATE ip_address<CR><LF>	ip_address - Format: xxx.xxx.xxx.xxx	Get gateway IP: #NET-GATE?<CR>
NET-IP?	Get a network IP address. This is an UDP protocol only.	#NET-IP?<CR>	~nn@NET-IP _net_ip<CR>< LF>	net_ip – Network IP	Get network ip address: #NET-IP?<CR>
NET-MAC?	Get subnet mask.	#NET-MASK?<CR>	~nn@NET-MASK net_mask<CR><LF>	Net_mask - Format: xxx.xxx.xxx.xxx	Get subnet mask: #NET-MASK?<CR>
NET-MASK?	Get MAC address.	#NET-MAC?<CR>	~nn@NET-MAC _mac_addres s<CR><LF>	mac_address – Unique MAC address. Format: XX-XX-XX-XX-XX-XX where X is hex digit	#NET-MAC?<CR>
NET-MTU	Set NIC MTU Mode.	#NET-MTU mode<CR>	~nn@NET-MTU mode<CR><LF>	mode: 0 – MTU with 1500 1 - Jumbo MTU with 9018	Set MTU to standard 1500: #NET-MTU 0<CR>
NET-MTU?	Get NIC MTU Mode.	#NET-MTU?<CR>	~nn@NET-MTU mode<CR><LF>	mode: 0 – MTU with 1500 1 - Jumbo MTU with 9018	Set MTU mode: #NET-MAC?<CR>
NET-SRV-802-1Q	Set a network service 802.1Q configuration.	#NET-SRV-802-1Q _ service_id,mode,vlan_id,co s<CR>	~nn@NET-SRV-802-1Q service_id,mode,vlan_id ,cos<CR><LF>	service_id – ID of the service: 0 – Control 1 – Service 2 – Dante mode – enable 802.1Q 0 – off (When mode is Off, vlan_id and cos will be ignored) 1 – on vlan_id – 2~4000 (Optional, when mode is 1, must be provided) cos – 0~7 (Optional, when mode is 1, must be provided)	Set Control Service 802.1Q enable with VLAN ID 10, Cos 6 #NET-802-1Q 0,1,10,6<CR> Set Media Service 802.1Q Off #NET-SRV-802-1Q 0,0<CR>

Function	Description	Syntax	Response	Parameters/Attributes	Example
NET-SRV-802-1Q?	Get a network service 802.1Q configuration.	#NET-SRV-802-1Q? service_id<CR>	~nn@NET-SRV-802-1Q service_id,mode,vlan_id ,cos<CR><LF>	service_id – ID of the service: 0 – Stream 1 – Control 2 – Dante mode – enable 802.1Q 0 – Off 1 – On vlan_id – 2~4000 cos – 0~7	Get Stream Service 802.1Q #NET-SRV-802-1Q? 0<CR>
NET-SRV-CONFIG	Set a network configuration for Application Services. NOTE: If the gateway address is not compliant to the subnet mask used for the host IP, the command will return an error. Subnet and gateway compliancy specified by RFC950. NOTE: This sets the device to DHCP OFF automatically.	#NET-SRV-CONFIG service_id,net_ip,net_mask ,gateway,dns<CR>	~nn@NET-SRV-CONFIG service_id,net_ip,net_m ask,gateway,dns<CR><LF>	service_id – ID of the service: 0 – Control 1 – Service 2 – Dante net_ip – Network IP net_mask – Network mask gateway – Network gateway dns – DNS address	Set the device control service network to IP address 192.168.113.10, net mask 255.255.0.0, and gateway 192.168.0.1: #NET-SRV-CONFIG 0,192.168.113.10,255.255.0.0,192.168.0.1<CR>
NET-SRV-CONFIG?	Get the network configuration for application services.	#NET-SRV-CONFIG? service_id <CR>	~nn@NET-SRV-CONFIG service_id,net_ip,net_m ask,gateway,dns<CR><LF>	service_id – ID of the service: 0 – Control 1 – Service 2 – Dante net_ip – Network IP net_mask – Network mask gateway – Network gateway dns – DNS address	Get network configuration for control service: #NET-SRV-CONFIG? 0<CR>
NET-SRV-DHCP	Set DHCP mode on application services. NOTE: To disable DHCP, the user must configure a static IP address for the device. Connecting Ethernet to devices with DHCP may take more time in some networks.	#NET-SRV-DHCP service_id,dhcp_state<CR>	~nn@NET-SRV-DHCP service_id,dhcp_state <CR><LF>	service_id – ID of the service: 0 – Control 1 – Service 2 – Dante dhcp_state – 1 – Try to use DHCP. (If unavailable, use the IP address set by the factory or the net-ip command).	Enable DHCP mode for port 0, if available: #NET-SRV-DHCP 0,1<CR>
NET-SRV-DHCP?	Set a network service DSCP configuration.	#NET-SRV-DHCP? service_id<CR>	~nn@NET-SRV-DHCP service_id,dhcp_state <CR><LF>	service_id – ID of the service: 0 – Control 1 – Service 2 – Dante dhcp_state – 1 – Try to use DHCP. (If unavailable, use the IP address set by the factory or the net-ip command).	Get DHCP mode for control service: #NET-SRV-DHCP? 0<CR>
NET-SRV-DSCP	Set a network service DSCP configuration.	#NET-SRV-DSCP service_id,dscp<CR>	~nn@NET-SRV-DSCP service_id,dscp <CR><LF>	service_id – ID of the service: 0 – Control 1 – Service 2 – Dante dscp – 0~63	Set Control Service DSCP as 63 #NET-SRV-DSCP 0,63
NET-SRV-DSCP?	Get the network service DSCP configuration.	#NET-SRV-DSCP? service_id<CR>	~nn@NET-SRV-DSCP service_id,dscp <CR><LF>	service_id – ID of the service: 0 – Control 1 – Service 2 – Dante dscp – 0~63	Get the Control Service DSCP #NET-SRV-DSCP 0
NET-STAT?	Get net connection list of this machine. NOTE: The response is returned in one line and terminated with<CR><LF>. The response format lists signal IDs separated by commas. This is an Extended Protocol 3000 command.	#NET-STAT?<CR>	~nn@NET- STAT_([(<port_type>:<po rt_index>,<client_ip>:<cl ient_port>),state],.. ,<CR><LF>	port_type – TCP/UDP 0 - TCP 1 - UDP port_index – Device port client_ip – Dot-separated representation of the IP address client_port – Client port state – listen or established	Get net connection list of this machine: #NET-STATE?<CR> ~01@NETSTAT_[(TCP:80,0 .0.0.0:),LISTEN],[TCP:5000 .0.0.0:0),LISTEN], [(TCP:80,192.168.114.3:5240 0),ESTABLISHED],[TCP:500 0,192.168.1.100:51647) ,ESTABLISHED]<CR><LF>
PASS	Set password for login level. The default password is "admin".	#PASS_ login_level,password <CR>	~nn@PASS_ login_level,p assword<CR><LF>	login_level – Level of login to set (admin support only). password – Password for the login_level. 8 to 24 characters (letters, numbers, and symbols without spaces or commas), at least including one number, one symbols without spaces or commas, one uppercase letter and one lowercase letter.	Set the password for the admin protocol permission level to 33333: #PASS_ admin,33333<CR>
PASS?	Get password for login level. The default password is "admin".	#PASS?_ login_level<CR>	~nn@PASS_ login_level,p assword<CR><LF>	login_level – Level of login to set (End User or Administrator). password – Password for the login_level.	Get the password for the admin protocol permission level: #PASS?_ admin<CR>

Function	Description	Syntax	Response	Parameters/Attributes	Example
PORT-DIRECTION	Set port direction as input or output.	#PORT-DIRECTION_<direction_type>.<port_format>.<port_index>.<signal_type>,direction<CR>	~nn@PORT-DIRECTION_<direction_type>.<port_format>.<port_index>.<signal_type>,direction<CR><LF>	The following attributes comprise the signal ID: <direction_type> – Direction of the port: IN – Input OUT – Output BOTH – Bi-directional <port_format> – Type of signal on the port: ANALOG_AUDIO IR <port_index> – The port number as printed on the front or rear panel <signal_type> – Signal ID attribute: AUDIO IR <direction> – Direction of the port: IN – Input OUT – Output	Set audio analog port direction as input: #PORT-DIRECTION_<both>.analog.1.audio,IN<CR>
PORT-DIRECTION?	Get port direction.	#PORT-DIRECTION?_<direction_type>.<port_format>.<port_index>.<signal_type><CR>	~nn@PORT-DIRECTION_<direction_type>.<port_format>.<port_index>.<signal_type>,direction<CR><LF>	The following attributes comprise the signal ID: <direction_type> – Direction of the port: IN – Input OUT – Output BOTH – Bi-directional <port_format> – Type of signal on the port: ANALOG_AUDIO IR <port_index> – The port number as printed on the front or rear panel <signal_type> – Signal ID attribute: AUDIO IR <direction> – Direction of the port: IN – Input OUT – Output	Get audio analog port direction: #PORT-DIRECTION?_<both>.analog.1.audio<CR>
PORTS-LIST?	Get the port list of this machine. NOTE: The response is returned in one line and terminated with<CR><LF>. The response format lists port IDs separated by commas. This is an Extended Protocol 3000 command.	#PORTS-LIST?<CR>	~nn@PORTS-LIST_ [<direction_type>.<port_format>.<port_index>,...]<CR><LF>	The following attributes comprise the port ID: <direction_type> – Direction of the port: IN OUT BOTH <port_format> – Type of signal on the port: HDMI ANALOG_AUDIO RS-232 IR USB_A USB_B USB_C STREAM <port_index> – The port number as printed on the front or rear panel	Get the ports list: #PORTS-LIST?<CR>
PROT-VER?	Get device protocol version.	#PROT-VER?<CR>	~nn@PROT-VER 3000:version<CR><LF>	3000: - Prefix version - XX.XX where X is a decimal digit	Get the device protocol version: #PROT-VER?<CR>
RESET	Reset device NOTE: To avoid locking the port due to a USB bug in Windows, disconnect USB connections immediately after running this command. If the port was locked, disconnect and reconnect the cable to reopen the port.	#RESET<CR>	~nn@RESET_<ok><CR><LF>		Reset the device: #RESET<CR>
SECUR	Start/stop P3K communication security. NOTE: The permission system works only if security is enabled with the "SECUR" command.	#SECUR_<security_state><CR>	~nn@SECUR_<security_state><CR><LF>	security_state – Security state 0 - OFF (disables security) 1 - ON (enables security)	Enable the permission system: #SECUR_0<CR>
SECUR?	Get P3K security state.	#SECUR?<CR>	~nn@SECUR_<security_state><CR><LF>	security_state – Security state 0 - OFF (disables security) 1 - ON (enables security)	Get security state: #SECUR?<CR>
SET-MGR-IP	Set AVoIP Manager IP	#SET-MGR-IP mgrip<CR>	~nn@SET-MGR-IP mgrip<CR><LF>	mgrip: AVoIP Manager IP 0.0.0.0 - means no AVoIP Manager IP enabled.	Set MGR-IP as 192.168.1.2: #SET-MGR-IP 192.168.1.2<CR>

Function	Description	Syntax	Response	Parameters/Attributes	Example
SIGNALS-LIST?	Get signal ID list of this machine. NOTE: The response is returned in one line and terminated with<CR><LF>. The response format lists signal IDs separated by commas. This is an Extended Protocol 3000 command.	#SIGNALS-LIST?<CR><LF>	~nn@SIGNALS-LIST_ [<direction_type>.<port_format>.<port_label>.<signal_type>.<index>,<CR><LF>	The following attributes comprise the signal ID: <direction_type> – Direction of the port: IN - Input OUT - Output BOTH - Bi-directional (e.g. for RS-232) <port_format> – Type of signal on the port: HDMI ANALOG_AUDIO RS-232 IR USB_A USB_B USB_C STREAM <port_index> – The port number as printed on the front or rear panel <signal_type> – Signal ID attribute: VIDEO AUDIO RS232 IR USB <index> – Indicates a specific channel number when there are multiple channels of the same type	Get signal ID list: #SIGNALS-LIST?<CR>
SN?	Get device serial number.	#SN?<CR>	~nn@SN_ serial_num<CR><LF>	serial_num – 14 decimal digits, factory assigned	Get the device serial number: #SN?<CR>
TIME	Set device time and date. NOTE: The year must be 4 digits. The device does not validate the day of week from the date. Time format - 24 hours. Date format - Day, Month, Year.	#TIME_ day_of_week, date, data<CR>	~nn@TIME_ day_of_week, date, data<CR><LF>	day_of_week – One of {SUN,MON,TUE,WED,THU,FRI,SAT} date – Format: DD-MM-YYYY where YYYY = Year MM = Month DD = Day data – Format: hh:mm:ss where hh = hours mm = minutes ss = seconds	Set device time and date to December 5, 2018 at 2:30pm: #TIME_mon_05-12-2018,14:30:00<CR>
TIME?	Get device time and date. NOTE: The year must be 4 digits. The device does not validate the day of week from the date. Time format - 24 hours. Date format - Day, Month, Year.	#TIME?<CR>	~nn@TIME_ day_of_week, date, data<CR><LF>	day_of_week – One of {SUN,MON,TUE,WED,THU,FRI,SAT} date – Format: DD-MM-YYYY where YYYY = Year MM = Month DD = Day data – Format: hh:mm:ss where hh = hours mm = minutes ss = seconds	Get device time and date: #TIME?<CR>
TIME-SRV	Set time server. NOTE: This command is needed for setting UDP timeout for the current client list.	#TIME-SRV_ mode, time_server_ip, sync_hour<CR>	~nn@TIME-SRV_ mode, time_server_ip, sync_hour, server_status<CR><LF>	mode – On/Off 0 - Off 1 - On time_server_ip – Time server IP address sync_hour – Hour in day for time server sync server_status – On/Off	Set time server with IP address of 128.138.140.44 to ON: #TIME-SRV_1,128.138.140.44,0,1<CR>
TIME-SRV?	Get time server. NOTE: This command is needed for setting UDP timeout for the current client list.	#TIME-SRV?<CR>	~nn@TIME-SRV_ mode, time_server_ip, sync_hour, server_status<CR><LF>	mode – On/Off 0 - Off 1 - On time_server_ip – Time server IP address sync_hour – Hour in day for time server sync server_status – On/Off	Get time server: #TIME-SRV?<CR>
TIME-ZONE	Set the device time zone.	#TIME-ZONE timezone_str<CR>	~nn@TIME-ZONE timezone_str<CR><LF>	timezone_str – A string that identifies the relevant time zone. Available time zone strings can be listed using the TIME-ZONE-LIST? command.	Set time zone to London, England: #TIME-ZONE europe/london<CR>
TIME-ZONE?	Get the device time zone.	#TIME-ZONE?<CR>	~nn@TIME-ZONE timezone_str<CR><LF>	timezone_str – A string that identifies the relevant time zone. Available time zone strings can be listed using the TIME-ZONE-LIST? command.	Get the device time zone: #TIME-ZONE?<CR>

Function	Description	Syntax	Response	Parameters/Attributes	Example
UART	Set com port configuration. NOTE: In the FC-2x the serial port is selectable to RS-232 or RS-485 (usually serial port 1). If Serial is configured when RS-485 is selected, the RS-485 UART port automatically changes. The command is backward compatible, meaning that if the extra parameters do not exist, FW goes to RS-232. Stop_bits 1.5 is only relevant for 5 data_bits.	# UART <u>com_id</u> ,baud_rate,data_bits,parity,stop_bits_mode,serial_type,485_term< CR >	~nn@ UART <u>com_id</u> ,baud_rate,data_bits,parity,stop_bits_mode,serial_type,485_term< CR >< LF >	com_id – 1 to n (machine dependent) baud_rate – 9600 - 115200 data_bits – 5-8 parity – Parity Type 0 - No 1 - Odd 2 - Even stop_bits_mode – 1/1.5/2 serial_type – 232/485 0 - 232 1 - 485 485_term – 485 termination state 0 - disable 1 - enable (optional - this exists only when serial_type is 485)	Set baud rate to 9600, 8 data bits, parity to none and stop bit to 1: # UART <u>9600,8,node,1</u> < CR >
UART?	Get com port configuration. NOTE: In the FC-2x the serial port is selectable to RS-232 or RS-485 (usually serial port 1). If Serial is configured when RS-485 is selected, the RS-485 UART port automatically changes. The command is backward compatible, meaning that if the extra parameters do not exist, FW goes to RS-232. Stop_bits 1.5 is only relevant for 5 data_bits.	# UART? <u>com_id</u> < CR >	~nn@ UART <u>com_id</u> ,baud_rate,data_bits,parity,stop_bits_mode,serial_type,485_term< CR >< LF >	com_id – 1 to n (machine dependent) baud_rate – 9600 - 115200 data_bits – 5-8 parity – Parity Type 0 - No 1 - Odd 2 - Even stop_bits_mode – 1/1.5/2 serial_type – 232/485 0 - 232 1 - 485 485_term – 485 termination state 0 - disable 1 - enable (optional - this exists only when serial_type is 485)	Set baud rate to 9600, 8 data bits, parity to none and stop bit to 1: # UART <u>1,9600,8,node,1</u> < CR >
UPG-TIME?	Get firmware version last upgrade date/time Add New Command for KDS-7	# UPG-TIME? < CR >	~nn@ UPG-TIME <u>date</u> ,data< CR >< LF >	date – Format: DD-MM-YYYY. data – Format: hh:mm:ss where	Get last upgrade date/time: # UPG-TIME? < CR >
UPGRADE	Perform firmware upgrade. NOTE: Not necessary for some devices. Firmware usually uploads to a device via a command like LDFW. Reset the device to complete the process.	# UPGRADE < CR >	~nn@ UPGRADE <u>ok</u> < CR >< LF >		Perform firmware upgrade: # UPGRADE < CR >
VERSION?	Get firmware version number.	# VERSION? < CR >	~nn@ VERSION <u>firmware_version</u> < CR >< LF >	firmware_version – XX.XX.XXXX where the digit groups are: major.minor.build version	Get the device firmware version number: # VERSION? < CR >
VIDEO-WALL-SETUP	Define device video wall relative position and video alignment. For KDS-17DEC NOTE: MUST setup with "#VIEW-MOD 15" or "#VIEW-MOD 16" to video wall mode firstly	# VIDEO-WALL-SETUP <u>out_id</u> ,rotation< CR >	~nn@ VIDEO-WALL-SETUP <u>out_id</u> ,rotation< CR >< LF >	out_id – Number of output (1-256), =1 when view mode is 16 rotation – Rotation degrees in clockwise 0 - 0 degrees 1 - 90 degrees 2 - 180 degrees 3 - 270 degrees	Set video alignment: # VIDEO-WALL-SETUP <u>10,1</u> < CR >
VIDEO-WALL-SETUP?	Get device video wall relative position and video alignment. For KDS-17DEC	# VIDEO-WALL-SETUP? < CR >	~nn@ VIDEO-WALL-SETUP <u>out_id</u> ,rotation< CR >< LF >	out_id – Number of output (1-256), =1 when view mode is 16 rotation – Rotation degrees in clockwise 0 - 0 degrees 1 - 90 degrees 2 - 180 degrees 3 - 270 degrees	Get video alignment: # VIDEO-WALL-SETUP? < CR >
VIEW-MOD	Set view mode. In case of KDS-7 only Video wall mode is supported. Second and third parameters are "mode" specific. In case of video wall, they define video wall layout, use "VIEW-MOD 15,1,1" for disabling video wall. For KDS-17DEC	# VIEW-MOD <u>mode</u> ,vw_hsize,vw_vsize< CR > or # VIEW-MOD <u>mode</u> ,x1,y1,x2,y2< CR >	~nn@ VIEW-MOD <u>mode</u> < CR >< LF >	mode – View Modes 15 - Video wall 16 - Mosaic style video wall vw_hsize – video wall horrible size, only required when mode is 15 vw_vsize – video wall vertical size, only required when mode is 15 (x1, y1) - will be the virtual coordinates of top left position, only required when mode is 16 (x2, y2) - will be the virtual coordinates of bottom right position, only required when mode is 16 the range for x1, y1, x2, y2 is: 0 ~ 10000.	Set view mode to a 2x2 grid video wall: # VIEW-MOD <u>15,2,2</u> < CR > Set view mode to a mosaic style video wall for show 1/4 top left image: # VIEW-MOD <u>16,0,0,5000,5000</u> < CR >

Function	Description	Syntax	Response	Parameters/Attributes	Example
VIEW-MOD?	Get view mode. (KDS-17DEC only)	#VIEW-MOD?<CR>	~nn@VIEW-MOD_ mode, vw_h size, vw_vsize <CR><LF> or ~nn@VIEW-MOD_ mode, x1, y 1, x2, y2<CR><LF>	mode – View Modes 15 - Video wall 16 - Mosaic style video wall vw_hsize – video wall horrible size, only required when mode is 15 vw_vsize – video wall vertical size, only required when mode is 15 (x1, y1) - will be the virtual coordinates of top left position, only required when mode is 16 (x2, y2) - will be the virtual coordinates of bottom right position, only required when mode is 16 the range for x1, y1, x2, y2 is: 0 ~ 10000.	Get view mode: #VIEW-MOD?<CR>
WND-STRETCH	Set video wall stretch. For KDS-17DEC	#WND- STRETCH_ out_index, mode<CR>	~nn@WND- STRETCH_ out_index, mode <CR><LF>	out_index – Number that indicates the specific output 1-256: 1-N (N= the total number of outputs) mode – Stretch mode: 0 - fit in 1 - fit out	Set Video Wall Stretch Type is Fit In: #WND-STRETCH_ 1, 0<CR>
WND-STRETCH?	Get video wall stretch. For KDS-17DEC.	#WND- STRETCH? _out_index<CR>	~nn@WND- STRETCH_ out_index, mode <CR><LF>	out_index – Number that indicates the specific output 1-256: 1-N (N= the total number of outputs) mode – Stretch mode: 0 - fit in 1 - fit out	Get Video Wall Stretch Type: #WND-STRETCH? _1<CR>
X-AUD-DESC?	Get audio signal info. NOTE: + This is an Extended Protocol 3000 command. + On KDS7 only support active port, so for KDS- SW2-EN7, KDS-SW3- EN7, WP-SW2-EN7, <port_format> HDMI also identify the USB-C audio format if USB-C is active.	#X-AUD- DESC? _<direction_type>.<po rt_format>.<port_index><CR >	~nn@X-AUD- DESC? _<direction_type> <port_format>.<port_in dex>.<signal_type>.<ind ex>, ch_tot, samp_rate, au d_format<CR><LF>	The following attributes comprise the signal ID: <direction_type> – Direction of the port: IN - Input OUT - Output BOTH - Bi-directional (e.g. for RS- 232) <port_format> – Type of signal on the port: HDMI ANALOG_AUDIO STREAM DANTE – Only available on KDS- SW3-EN7 <port_index> – The port number as printed on the front or rear panel <signal_type> – Signal ID attribute: AUDIO <index> – Indicates a specific channel number when there are multiple ch_tot – Total number of channels samp_rate – Sample rate aud_format – Audio Format: LPCM - Linear Pulse Code Modulation audio Non-LPCM - None Linear Pulse Code Modulation audio, like Dolby Digital, DTS, etc. HBR - High Bitrate Audio, like Dolby TrueHD, DTS HD Master Audio.	Get the audio signal info: #X-AUD- DESC? _out.hDMI.1<CR>
X-AUD-LVL	Set audio level of a specific signal. NOTE: This is an Extended Protocol 3000 command.	#X-AUD- LVL_<direction_type>.<port _format>.<port_index>.<sig nal_type>.<index>, audio_le vel<CR>	~nn@X-AUD-LVL_<directi on_type>.<port_format>. <port_index>.<signal_ty pe>.<index>, audio_level <CR><LF>	The following attributes comprise the signal ID: <direction_type> – Direction of the port: OUT – Output <port_format> – Type of signal on the port: ANALOG_AUDIO <port_index> – The port number as printed on the front or rear panel <signal_type> – Signal ID attribute: AUDIO <index> – Indicates a specific channel number when there are multiple channels of the same type audio_level – Audio level (range between 0 to 100)	Set the audio level of a specific signal to 80: #X-AUD- LVL_ in.analog_audio.1.audi o.1,80<CR>

Function	Description	Syntax	Response	Parameters/Attributes	Example
X-AUD-LVL?	Get audio level of a specific signal. NOTE: This is an Extended Protocol 3000 command.	#X-AUD- LVL? <direction_type>.<port_format>.<port_index>.<signal_type>.<index><CR>	~nn@X-AUD- LVL <direction_type>.<port_format>.<port_index>.<signal_type>.<index>,<audio_level><CR><LF>	The following attributes comprise the signal ID: <direction_type> – Direction of the port: OUT – Output <port_format> – Type of signal on the port: ANALOG_AUDIO <port_index> – The port number as printed on the front or rear panel <signal_type> – Signal ID attribute: AUDIO <index> – Indicates a specific channel number when there are multiple channels of the same type audio_level – Audio level (range between 0 to 100)	Get the audio level of a specific signal: #X-AUD- LVL?_out.analog_audio.1.audio.1<CR>
X-AV-SW-MODE	Set auto-switch mode per output. NOTE: This is an Extended Protocol 3000 command.	#X-AV-SW- MODE <direction_type>.<port_format>.<port_index>.<signal_type>.<index>,<connection_mode><CR>	~nn@X-AV-SW- MODE <direction_type>.<port_format>.<port_index>.<signal_type>.<index>,<connection_mode><CR><LF>	The following attributes comprise the signal ID: <direction_type> – Direction of the port: OUT – Output <port_format> – Type of signal on the port: HDMI ANALOG_AUDIO STREAM <port_index> – The port number as printed on the front or rear panel <signal_type> – Signal ID attribute: VIDEO AUDIO <index> – Indicates a specific channel number when there are multiple channels of the same type connection_mode – Connection mode 0 - manual 1 - priority 2 - last connected	Set auto switch mode for HDMI OUT 1 (last connected): #X-AV-SW- MODE_out.hdmi.1.video.1,2<CR>
X-AV-SW-MODE?	Get auto-switch mode. NOTE: This is an Extended Protocol 3000 command.	#X-AV-SW- MODE? <direction_type>.<port_format>.<port_index>.<signal_type>.<index><CR>	~nn@X-AV-SW- MODE <direction_type>.<port_format>.<port_index>.<signal_type>.<index>,<connection_mode><CR><LF>	The following attributes comprise the signal ID: <direction_type> – Direction of the port: OUT – Output <port_format> – Type of signal on the port: HDMI ANALOG_AUDIO STREAM <port_index> – The port number as printed on the front or rear panel <signal_type> – Signal ID attribute: VIDEO AUDIO <index> – Indicates a specific channel number when there are multiple channels of the same type connection_mode – Connection mode 0 - manual 1 - priority 2 - last connected	Get auto switch mode for HDMI OUT 1: #X-AV-SW- MODE?_out.hdmi.1.video.1<CR>
X-MUTE	Set mute ON/OFF on a specific signal. Note: For KDS-17EN, HDMI, STREAM mute will effect each other, and if the HDMI/STREAM is mute, analog_audio will be mute too. It is a limitation.	#X- MUTE <direction_type>.<port_format>.<port_index>.<signal_type>.<index>,<state><CR>	~nn@X- MUTE <direction_type>.<port_format>.<port_index>.<signal_type>.<index>,<state><CR><LF>	<direction_type> – Direction of the port: OUT – Output <port_format> – Type of signal on the port: HDMI ANALOG_AUDIO STREAM ALL – All audio output <port_index> – The port number as printed on the front or rear panel <signal_type> – Signal ID attribute: AUDIO <index> – Indicates a specific channel number when there are multiple channels of the same type state – OFF/ON (not case sensitive)	Mute the audio on HDMI OUT 1: #X-MUTE_out.hdmi.1.audio.1,on<CR> Mute the audio on ALL OUT: #X-MUTE_out.all.1.audio.1,on<CR>

Function	Description	Syntax	Response	Parameters/Attributes	Example
X-ROUTE?	<p>Get routing status.</p> <p>NOTE: It is recommended to use the command #SIGNALS-LIST to get the list of all signal IDs available in the system and which can be used in this command.</p> <p>VIDEO.1 are the default <signal_type> and <index> in this command and are implied even if not written:</p> <p>#X-ROUTE? out.hdmi.1<CR> is interpreted as: #X-ROUTE? out.hdmi.1.video.1<CR></p> <p>This is an Extended Protocol 3000 command.</p>	<pre>#X-ROUTE? <direction_type1> .<port_type1>.<port_index1>.<signal_type1>.<index1> <CR></pre>	<pre>~nn#X-ROUTE <direction_type1>.<port_type1>.<port_index1>.<signal_type1>.<index1>,<direction_type2>.<port_type2>.<port_index2>.<signal_type2>.<index2> <CR><LF></pre>	<p>The following attributes comprise the signal ID:</p> <p><direction_type> – Direction of the port: IN - Input OUT - Output BOTH - Bi-directional (e.g. for RS-232)</p> <p><port_format> – Type of signal on the port: HDMI ANALOG_AUDIO STREAM DANTE – Only available on KDS-SW3-EN7</p> <p><port_index> – The port number as printed on the front or rear panel</p> <p><signal_type> – Signal ID attribute: VIDEO AUDIO</p> <p><index> – Indicates a specific channel number when there are multiple channels of the same type</p>	<p>Get the routing status:</p> <pre>#X-ROUTE? out.hdmi.1.video.1 <CR></pre>

12.3 Result and Error Codes

12.3.1 Syntax

In case of an error, the device responds with an error message. The error message syntax:

- **~NN@ERR XXX<CR><LF>** – when general error, no specific command
- **~NN@CMD ERR XXX<CR><LF>** – for specific command
- **NN** – machine number of device, default = 01
- **XXX** – error code

12.3.2 Error Codes

Error Name	Error Code	Description
P3K_NO_ERROR	0	No error
ERR_PROTOCOL_SYNTAX	1	Protocol syntax
ERR_COMMAND_NOT_AVAILABLE	2	Command not available
ERR_PARAMETER_OUT_OF_RANGE	3	Parameter out of range
ERR_UNAUTHORIZED_ACCESS	4	Unauthorized access
ERR_INTERNAL_FW_ERROR	5	Internal FW error
ERR_BUSY	6	Protocol busy
ERR_WRONG_CRC	7	Wrong CRC
ERR_TIMEOUT	8	Timeout
ERR_RESERVED	9	(Reserved)
ERR_FW_NOT_ENOUGH_SPACE	10	Not enough space for data (firmware, FPGA...)
ERR_FS_NOT_ENOUGH_SPACE	11	Not enough space – file system
ERR_FS_FILE_NOT_EXISTS	12	File does not exist
ERR_FS_FILE_CANT_CREATED	13	File can't be created
ERR_FS_FILE_CANT_OPEN	14	File can't open
ERR_FEATURE_NOT_SUPPORTED	15	Feature is not supported
ERR_RESERVED_2	16	(Reserved)
ERR_RESERVED_3	17	(Reserved)
ERR_RESERVED_4	18	(Reserved)
ERR_RESERVED_5	19	(Reserved)
ERR_RESERVED_6	20	(Reserved)
ERR_PACKET_CRC	21	Packet CRC error
ERR_PACKET_MISSED	22	Packet number isn't expected (missing packet)
ERR_PACKET_SIZE	23	Packet size is wrong
ERR_RESERVED_7	24	(Reserved)
ERR_RESERVED_8	25	(Reserved)
ERR_RESERVED_9	26	(Reserved)
ERR_RESERVED_10	27	(Reserved)
ERR_RESERVED_11	28	(Reserved)
ERR_RESERVED_12	29	(Reserved)
ERR_EDID_CORRUPTED	30	EDID corrupted
ERR_NON_LISTED	31	Device specific errors
ERR_SAME_CRC	32	File has the same CRC – not changed
ERR_WRONG_MODE	33	Wrong operation mode
ERR_NOT_CONFIGURED	34	Device/chip was not initialized

13 Warranty

The warranty obligations of Kramer Electronics Inc. ("Kramer Electronics") for this product are limited to the terms set forth below:

What is Covered

This limited warranty covers defects in materials and workmanship in this product.

What is Not Covered

This limited warranty does not cover any damage, deterioration or malfunction resulting from any alteration, modification, improper or unreasonable use or maintenance, misuse, abuse, accident, neglect, exposure to excess moisture, fire, improper packing and shipping (such claims must be presented to the carrier), lightning, power surges, or other acts of nature. This limited warranty does not cover any damage, deterioration or malfunction resulting from the installation or removal of this product from any installation, any unauthorized tampering with this product, any repairs attempted by anyone unauthorized by Kramer Electronics to make such repairs, or any other cause which does not relate directly to a defect in materials and/or workmanship of this product. This limited warranty does not cover cartons, equipment enclosures, cables or accessories used in conjunction with this product.

Without limiting any other exclusion herein, Kramer Electronics does not warrant that the product covered hereby, including, without limitation, the technology and/or integrated circuit(s) included in the product, will not become obsolete or that such items are or will remain compatible with any other product or technology with which the product may be used.

How Long this Coverage Lasts

The standard limited warranty for Kramer products is seven (7) years from the date of original purchase, with the following exceptions:

1. All Kramer VIA hardware products are covered by a standard three (3) year warranty for the VIA hardware and a standard three (3) year warranty for firmware and software updates; all Kramer VIA accessories, adapters, tags, and dongles are covered by a standard one (1) year warranty.
2. Kramer fiber optic cables, adapter-size fiber optic extenders, pluggable optical modules, active cables, cable retractors, ring mounted adapters, portable power chargers, Kramer speakers, and Kramer touch panels are covered by a standard one (1) year warranty. Kramer 7-inch touch panels purchased on or after April 1st, 2020 are covered by a standard two (2) year warranty.
3. All Kramer Calibre products, all Kramer Minicom digital signage products, all HighSecLabs products, all streaming, and all wireless products are covered by a standard three (3) year warranty.
4. All Sierra Video MultiViewers are covered by a standard five (5) year warranty.
5. Sierra switchers & control panels are covered by a standard seven (7) year warranty (excluding power supplies and fans that are covered for three (3) years).
6. K-Touch software is covered by a standard one (1) year warranty for software updates.
7. All Kramer passive cables are covered by a lifetime warranty.

Who is Covered

Only the original purchaser of this product is covered under this limited warranty. This limited warranty is not transferable to subsequent purchasers or owners of this product.

What Kramer Electronics Will Do

Kramer Electronics will, at its sole option, provide one of the following three remedies to whatever extent it shall deem necessary to satisfy a proper claim under this limited warranty:

1. Elect to repair or facilitate the repair of any defective parts within a reasonable period of time, free of any charge for the necessary parts and labor to complete the repair and restore this product to its proper operating condition. Kramer Electronics will also pay the shipping costs necessary to return this product once the repair is complete.
2. Replace this product with a direct replacement or with a similar product deemed by Kramer Electronics to perform substantially the same function as the original product. If a direct or similar replacement product is supplied, the original product's end warranty date remains unchanged and is transferred to the replacement product.
3. Issue a refund of the original purchase price less depreciation to be determined based on the age of the product at the time remedy is sought under this limited warranty.

What Kramer Electronics Will Not Do Under This Limited Warranty

If this product is returned to Kramer Electronics or the authorized dealer from which it was purchased or any other party authorized to repair Kramer Electronics products, this product must be insured during shipment, with the insurance and shipping charges prepaid by you. If this product is returned uninsured, you assume all risks of loss or damage during shipment. Kramer Electronics will not be responsible for any costs related to the removal or re-installation of this product from or into any installation. Kramer Electronics will not be responsible for any costs related to any setting up this product, any adjustment of user controls or any programming required for a specific installation of this product.

How to Obtain a Remedy Under This Limited Warranty

To obtain a remedy under this limited warranty, you must contact either the authorized Kramer Electronics reseller from whom you purchased this product or the Kramer Electronics office nearest you. For a list of authorized Kramer Electronics resellers and/or Kramer Electronics authorized service providers, visit our web site at www.kramerav.com or contact the Kramer Electronics office nearest you.

In order to pursue any remedy under this limited warranty, you must possess an original, dated receipt as proof of purchase from an authorized Kramer Electronics reseller. If this product is returned under this limited warranty, a return authorization number, obtained from Kramer Electronics, will be required (RMA number). You may also be directed to an authorized reseller or a person authorized by Kramer Electronics to repair the product.

If it is decided that this product should be returned directly to Kramer Electronics, this product should be properly packed, preferably in the original carton, for shipping. Cartons not bearing a return authorization number will be refused.

Limitation of Liability

THE MAXIMUM LIABILITY OF KRAMER ELECTRONICS UNDER THIS LIMITED WARRANTY SHALL NOT EXCEED THE ACTUAL PURCHASE PRICE PAID FOR THE PRODUCT. TO THE MAXIMUM EXTENT PERMITTED BY LAW, KRAMER ELECTRONICS IS NOT RESPONSIBLE FOR DIRECT, SPECIAL, INCIDENTAL OR CONSEQUENTIAL DAMAGES RESULTING FROM ANY BREACH OF WARRANTY OR CONDITION, OR UNDER ANY OTHER LEGAL THEORY. Some countries, districts or states do not allow the exclusion or limitation of relief, special, incidental, consequential or indirect damages, or the limitation of liability to specified amounts, so the above limitations or exclusions may not apply to you.

Exclusive Remedy

TO THE MAXIMUM EXTENT PERMITTED BY LAW, THIS LIMITED WARRANTY AND THE REMEDIES SET FORTH ABOVE ARE EXCLUSIVE AND IN LIEU OF ALL OTHER WARRANTIES, REMEDIES AND CONDITIONS, WHETHER ORAL OR WRITTEN, EXPRESS OR IMPLIED. TO THE MAXIMUM EXTENT PERMITTED BY LAW, KRAMER ELECTRONICS SPECIFICALLY DISCLAIMS ANY AND ALL IMPLIED WARRANTIES, INCLUDING, WITHOUT LIMITATION, WARRANTIES OF MERCHANTABILITY AND FITNESS FOR A PARTICULAR PURPOSE. IF KRAMER ELECTRONICS CANNOT LAWFULLY DISCLAIM OR EXCLUDE IMPLIED WARRANTIES UNDER APPLICABLE LAW, THEN ALL IMPLIED WARRANTIES COVERING THIS PRODUCT, INCLUDING WARRANTIES OF MERCHANTABILITY AND FITNESS FOR A PARTICULAR PURPOSE, SHALL APPLY TO THIS PRODUCT AS PROVIDED UNDER APPLICABLE LAW. IF ANY PRODUCT TO WHICH THIS LIMITED WARRANTY APPLIES IS A "CONSUMER PRODUCT" UNDER THE MAGNUSON-MOSS WARRANTY ACT (15 U.S.C.A. §2301, ET SEQ.) OR OTHER APPLICABLE LAW, THE FOREGOING DISCLAIMER OF IMPLIED WARRANTIES SHALL NOT APPLY TO YOU, AND ALL IMPLIED WARRANTIES ON THIS PRODUCT, INCLUDING WARRANTIES OF MERCHANTABILITY AND FITNESS FOR THE PARTICULAR PURPOSE, SHALL APPLY AS PROVIDED UNDER APPLICABLE LAW.

Other Conditions

This limited warranty gives you specific legal rights, and you may have other rights which vary from country to country or state to state. This limited warranty is void if (i) the label bearing the serial number of this product has been removed or defaced, (ii) the product is not distributed by Kramer Electronics or (iii) this product is not purchased from an authorized Kramer Electronics reseller. If you are unsure whether a reseller is an authorized Kramer Electronics reseller, visit our web site at www.kramerav.com or contact a Kramer Electronics office from the list at the end of this document. Your rights under this limited warranty are not diminished if you do not complete and return the product registration form or complete and submit the online product registration form. Kramer Electronics thanks you for purchasing a Kramer Electronics product. We hope it will give you years of satisfaction.



HDMITM
HIGH-DEFINITION MULTIMEDIA INTERFACE



P/N:

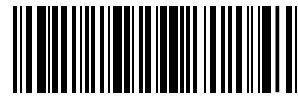

2900-301718

Rev:



3



SAFETY WARNING

Disconnect the unit from the power supply before opening and servicing

For the latest information on our products and a list of Kramer distributors, visit our website where updates to this user manual may be found.

We welcome your questions, comments, and feedback.

The terms HDMI, HDMI High-Definition Multimedia Interface, and the HDMI Logo are trademarks or registered trademarks of HDMI Licensing Administrator, Inc.

All brand names, product names, and trademarks are the property of their respective owners.