



USER MANUAL

MODELS:

EXT3-C-XR-T 4K60 USB-C Transmitter

EXT3-POE-XR-R 4K60 HDMI/USB Receiver

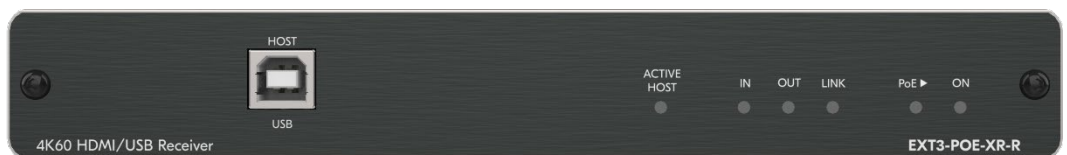
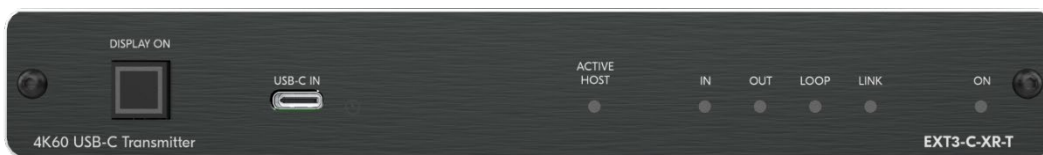

Contents

Introduction	1
Getting Started	1
Overview	2
Typical Applications	4
Defining EXT3-C-XR-T 4K60 USB-C Transmitter	5
Defining EXT3-POE-XR-R 4K60 HDMI/USB Receiver	7
Mounting EXT3-C-XR-T / EXT3-POE-XR-R	9
Connecting EXT3-C-XR-T and EXT3-POE-XR-R	10
Connecting EXT3-C-XR-T or EXT3-POE-XR-R to Other HDBaseT-compatible Devices	12
Connecting to EXT3-C-XR-T or EXT3-POE-XR-R via RS-232	13
Wiring RJ-45 Connectors	13
Setting the DIP-Switches	14
Display Power On/Off Control	14
Technical Specifications	15
EXT3-C-XR-T Specifications	15
EXT3-POE-XR-R Specifications	16

Introduction

Welcome to Kramer Electronics! Since 1981, Kramer Electronics has been providing a world of unique, creative, and affordable solutions to the vast range of problems that confront the video, audio, presentation, and broadcasting professional on a daily basis. In recent years, we have redesigned and upgraded most of our line, making the best even better!

Getting Started

We recommend that you:

- Unpack the equipment carefully and save the original box and packaging materials for possible future shipment.
- Review the contents of this user manual.



Go to www.kramerav.com/downloads/EXT3-C-XR-T or www.kramerav.com/downloads/EXT3-POE-XR-R to check for up-to-date user manuals, application programs, and to check if firmware upgrades are available (where appropriate).

Achieving Best Performance

- Use only good quality connection cables (we recommend Kramer high-performance, high-resolution cables) to avoid interference, deterioration in signal quality due to poor matching, and elevated noise levels (often associated with low quality cables).
- Do not secure the cables in tight bundles or roll the slack into tight coils.
- Avoid interference from neighboring electrical appliances that may adversely influence signal quality.
- Position your Kramer **EXT3-C-XR-T / EXT3-POE-XR-R** away from moisture, excessive sunlight and dust.

Safety Instructions



Caution:

- This equipment is to be used only inside a building. It may only be connected to other equipment that is installed inside a building.
- For products with relay terminals and GPIO ports, please refer to the permitted rating for an external connection, located next to the terminal or in the User Manual.
- There are no operator serviceable parts inside the unit.

**Warning:**

- Use only the power cord that is supplied with the unit.
- Disconnect the power and unplug the unit from the wall before installing.
- Do not open the unit. High voltages can cause electrical shock! Servicing by qualified personnel only.
- To ensure continuous risk protection, replace fuses only according to the rating specified on the product label which is located on the bottom of the unit.

Recycling Kramer Products

The Waste Electrical and Electronic Equipment (WEEE) Directive 2002/96/EC aims to reduce the amount of WEEE sent for disposal to landfill or incineration by requiring it to be collected and recycled. To comply with the WEEE Directive, Kramer Electronics has made arrangements with the European Advanced Recycling Network (EARN) and will cover any costs of treatment, recycling and recovery of waste Kramer Electronics branded equipment on arrival at the EARN facility. For details of Kramer's recycling arrangements in your particular country go to our recycling pages at www.kramerav.com/il/quality/environment.

Overview

Congratulations on purchasing your Kramer **EXT3-C-XR-T 4K60 USB-C Transmitter / EXT3-POE-XR-R 4K60 HDMI/USB Receiver**.

EXT3-C-XR-T USB-C transmitter and **EXT3-POE-XR-R** receiver are a high-performance, extended-reach HDBaseT 3.0 transmitter and receiver set for 4K60Hz (4:4:4) HDMI, USB, Ethernet, RS-232, and IR signals over twisted pair. The **EXT3-C-XR-T** transmitter converts all input signals into the transmitted HDBaseT 3.0 signal. The **EXT3-POE-XR-R** receives an HDBaseT 3.0 signal and converts it back into the original input signals. The **EXT3-POE-XR-R** receiver provides power over the copper extension cable to a POE (Power over Ethernet) acceptor device (such as the **EXT3-C-XR-T** transmitter), or accepts PoE through the extension cable from a PoE provider remote device, as auto-sensed by the receiver.

EXT3-C-XR-T and **EXT3-POE-XR-R** extend uncompressed video signals up to 100m (330ft) over CAT copper cables at 4K@60Hz (4:4:4) video resolution, providing exceptional quality, advanced and user-friendly operation, and flexible control.

Exceptional Quality

- High Performance Standard Extender – Professional HDBaseT extenders for providing extended-reach signals over twisted-pair copper infrastructures. **EXT3-C-XR-T** and **EXT3-POE-XR-R** are standard extenders that can be connected to any market-available HDBaseT-compliant extension product. For optimum extension reach and performance, use recommended Kramer cables.
- HDMI Signal Extension – Uncompressed 4K@60Hz (4:4:4) HDMI, HDCP 2.3, EDID and CEC signals are passed through from the source to the display.
- HDMI Support – Support HDR10, deep color, x.v.Color™, HDMI uncompressed audio channels, Dolby TrueHD, DTS-HD, 2K, 4K, and 3D as specified in HDMI 2.0.

- I-EDIDPro™ Kramer Intelligent EDID Processing™ – Intelligent EDID handling, processing, and pass-through algorithm that ensures Plug and Play operation for HDMI source and display systems.
- Multi-channel Audio Transmission – Up to 32 channels of digital stereo uncompressed signals for supporting studio-grade surround sound.

Advanced and User-friendly Operation

- BYOD Ease and Convenience – Connect to the **EXT3-C-XR-T** transmitter any DP-Alt-Mode-capable USB-C device as an AV presentation source, while providing the connected device with USB 2.0 and Ethernet connection, and (if PD-2.0-capable) up to 60 watts of power, via a single USB-C cable connection only.
- HDMI Mirroring – Transmitter-side extender mirrors input HDMI signal to loop output port for connecting a local monitor or an additional unit in a daisy chain.
- Convenient Display Power On/Off Control – Simply press the DISPLAY ON button on the **EXT3-C-XR-T** to toggle on and off the power of the remote CEC-enabled display; button LED indicates the power on/off status of the remote display.

Flexible Connectivity

- Flexible USB 2.0 Extension – An active USB host is connected to the extender at either the transmitter or receiver sides. USB 2.0 signals are extended between the extender transmitter and receiver sides, enabling connection of the active USB host to both local and remote USB devices, such as camera and audio devices, or HID (Human Interface Devices) mouse or keyboard devices.
- Ethernet Extension – Ethernet interface data flows in both directions, allowing extension of up to 1 Gbps Ethernet connectivity for LAN communication and device control.
- Bidirectional RS-232 Extension – Serial interface data flows in both directions, allowing data transmission and device control.
- Bidirectional Infrared Extension – IR interface data flows in both directions, allowing remote control of peripheral devices located at either end of the extended line.
- Remote Powering – The transmitter can be powered by PoE (power over ethernet), reducing the need for power sources. The receiver can either deliver or receive PoE.
- Cost-effective Maintenance – Status LED indicators for HDMI, Loop, HDBT, PoE and USB active host ports, facilitate easy local maintenance and troubleshooting.
- Easy and Elegant Installation – MegaTOOLS™ fan-less enclosure for dropped-ceiling mounting, or side-by-side mounting of 2 units in a 1U rack space with the recommended rack adapter.

Typical Applications

EXT3-C-XR-T and **EXT3-POE-XR-R** are ideal for the following typical applications:

- Corporate – Hybrid and online meetings.
- Education – Hybrid and online learning and training.
- Any AV, Ethernet and USB room extension applications such as conference rooms, boardrooms, and training facilities.

Defining EXT3-C-XR-T 4K60 USB-C Transmitter

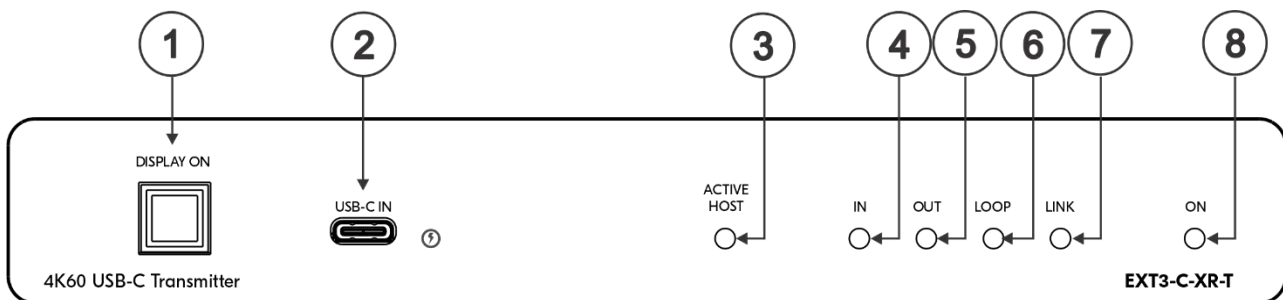

Figure 1: EXT3-C-XR-T 4K60 USB-C Transmitter Front Panel

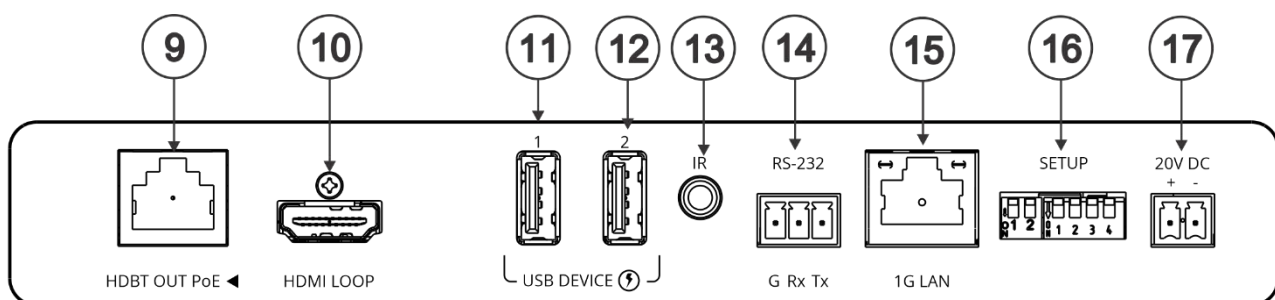

Figure 2: EXT3-C-XR-T 4K60 USB-C Transmitter Rear Panel

#	Feature	Function
①	DISPLAY ON Button	Press to toggle power on/off the remote CEC-enabled display that is connected to the receiver side. Button LED lights blue when remote display power is on.
②	USB-C IN Connector	Connect to a USB-C AV source (that supports DisplayPort Alternate Mode) for AV input, USB host connection to local and remote connected USB devices (when the device DIP-switch is set to active host as defined in Setting the DIP-Switches on page 12), and LAN connection. Charges sources (that support USB Power Delivery 2.0) up to 60W when the device is powered via the power adapter). While charging, the charging icon (to the right of the connector) becomes visible and lights orange. Note that an active host can be set only on one device, either the transmitter or the receiver, not both.
③	ACTIVE HOST LED	Lights orange when the USB host side is active.
④	IN LED	Lights blue when an active AV input signal is detected from the source device connected to the USB-C.
⑤	OUT LED	Lights blue when an HDMI output device is detected on the receiver side.
⑥	LOOP LED	Lights blue an active signal is transmitted on the HDMI LOOP port.
⑦	LINK LED	Lights green when the HDBT connection is active.
⑧	ON LED	Lights green when receiving power.
⑨	HDBT OUT PoE RJ-45 Connector	Connects to the HDBT IN RJ-45 connector on a receiver (for example, EXT3-POE-XR-R). Receives PoE (PD).
⑩	HDMI LOOP Connector	Connect to a local acceptor.

#	Feature	Function
⑪	USB A 2.0 Charging Connector 1	Connect to the USB local peripheral devices (for example, a USB PTZ camera). When USB Host PC is disconnected, the USB signal and charging power for this port are inactive.
⑫	USB A 2.0 Charging Connector 2	Connect to the USB local peripheral devices (for example, a USB camera, a soundbar, microphone and so on). When USB Host PC is disconnected, the USB charging power for this port continues to be active.
⑬	IR 3.5mm Mini Jack	Bidirectional IR connection. Outputs a received IR signal (from the HDBT receiver) to connected IR emitter or transmits an IR signal (from IR sensor) to the HDBT receiver.
⑭	RS-232 3-pin Terminal Block	Bidirectional RS-232 connection. Outputs a signal received from a controller device (for example, SL240C) to control a remote device via serial connection (for example, the remotely connected PTZ USB camera).
⑮	1G LAN RJ-45 Connector	Connect to a LAN for LAN-connection to the source device that is connected to the USB-C and Ethernet extension to the receiver.
⑯	SETUP 6-way DIP switch	Sets the device behavior (see Setting the DIP-Switches on page 14).
⑰	20V DC	+20V DC 6A connector for powering the unit and charging the connected input device to USB-C.

Defining EXT3-POE-XR-R 4K60 HDMI/USB Receiver

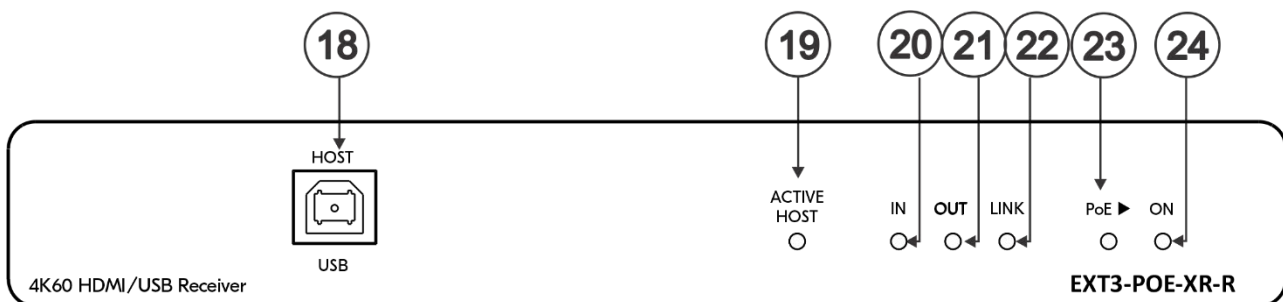

Figure 3: EXT3-POE-XR-R 4K60 HDMI/USB Receiver Rear Panel

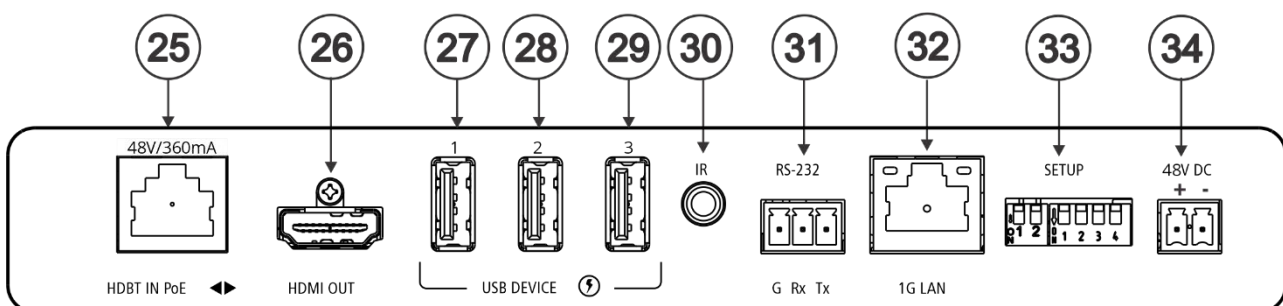

Figure 4: EXT3-POE-XR-R 4K60 HDMI/USB Receiver Rear Panel

#	Feature	Function
18	HOST USB B 2.0 Connector	When the device DIP-switch is set to active host as defined in Setting the DIP-Switches on page 12, connect a USB host (for example, a room PC) to communicate with the USB peripheral devices (for example, a smart board) connected to USB device ports on this device or the connected remote device. Note that an active host can be set only one device, either the transmitter or the receiver, not both.
19	ACTIVE HOST LED	Lights orange when the USB host side is active.
20	IN LED	Lights blue when an active HDMI input signal is detected on HDMI IN.
21	OUT LED	Lights blue when an output acceptor device is connected.
22	LINK LED	Lights green when the HDBT active link connection is established.
23	PoE LED	Lights green when power-providing over HDBT is active.
24	ON LED	Lights green when the device receives power.
25	HDBT IN PoE	Connect to the HDBT OUT connector on a paired PoE-accepting transmitter device (for example, a EXT3-C-XR-T device).
26	HDMI OUT	Connect to an HDMI acceptor.
27	USB A 2.0 Charging Connector 1	Connect to the USB local peripheral devices (for example, a USB PTZ camera). When the USB Host PC is disconnected, the USB signal and charging power for this port are inactive.
28	USB A 2.0 Charging Connectors 2-3	Connect to the USB local peripheral devices (for example, a USB camera, a soundbar, a microphone and so on). When the USB Host PC is disconnected, the USB charging power for this port continues to be active.
29		

#	Feature	Function
③0	IR 3.5mm Mini Jack Connector	Bidirectional IR connection. Outputs a received IR signal (from the HDBT transmitter) to connected IR emitter or transmits an IR signal (from IR sensor) to the HDBT transmitter.
③1	RS-232 3-pin Terminal Block	Bidirectional RS-232 connection. Outputs a signal received from a controller device (for example, SL-240C) to control a remote device via serial connection (for example, the remotely connected PTZ USB camera).
③2	1G LAN RJ-45 Connector	Connect to LAN for Ethernet extension to the transmitter.
③3	SETUP 6-way DIP switch	Sets the device behavior (see Setting the DIP-Switches on page 14).
③4	48V DC	Connect to the power supply.

Mounting EXT3-C-XR-T / EXT3-POE-XR-R

This section provides instructions for mounting the **EXT3-C-XR-T** transmitter and/or **EXT3-POE-XR-R** receiver. Before installing, verify that the environment is within the recommended range:



- Operation temperature – 0° to 40°C (32 to 104°F).
- Storage temperature – -40° to +70°C (-40 to +158°F).
- Humidity – 10% to 90%, RHL non-condensing.



Caution:

- Mount **EXT3-C-XR-T / EXT3-POE-XR-R** before connecting any cables or power.



Warning:

- Ensure that the environment (e.g., maximum ambient temperature & air flow) is compatible for the device.
- Avoid uneven mechanical loading.
- Appropriate consideration of equipment nameplate ratings should be used for avoiding overloading of the circuits.
- Reliable earthing of rack-mounted equipment should be maintained.
- Maximum mounting height for the device is 2 meters.

Mounting EXT3-C-XR-T / EXT3-POE-XR-R in a rack:

- Use the recommended rack adapter
(see www.kramerav.com/product/EXT3-C-XR-T).

Mount EXT3-C-XR-T / EXT3-POE-XR-R on a surface using one of the following methods:

- Attach the rubber feet and place the unit on a flat surface.
- Fasten a bracket (included) on each side of the unit and attach it to a flat surface. For more information go to www.kramerav.com/downloads/EXT3-C-XR-T.

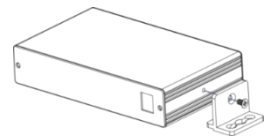

Connecting EXT3-C-XR-T and EXT3-POE-XR-R

i Switch off and disconnect the power to each device before connecting them. After connecting your devices, connect their power and power-up each device.

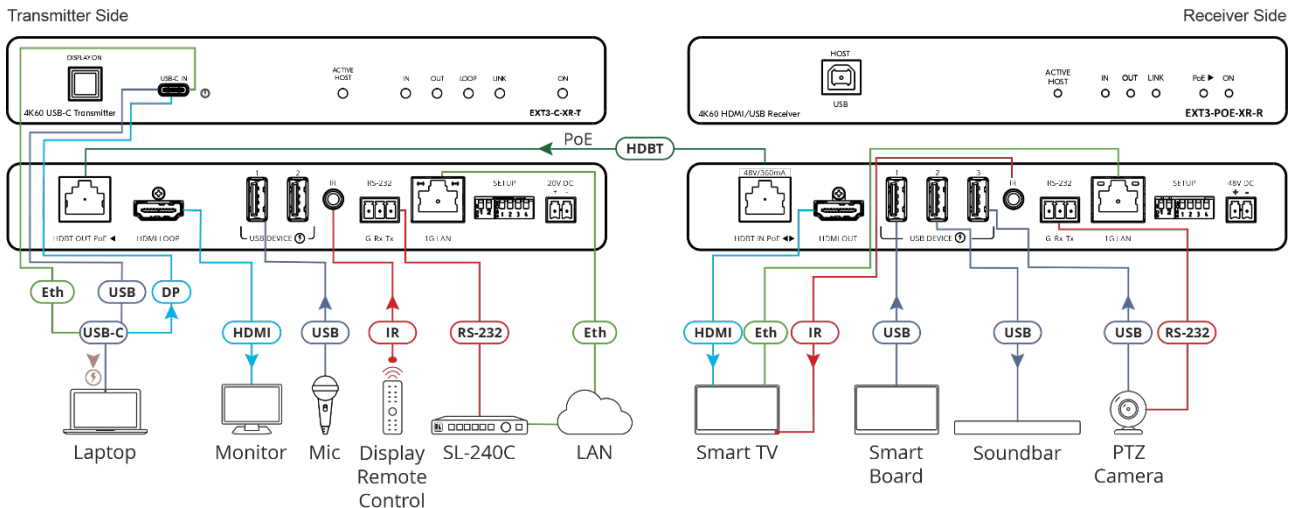

Figure 5: Connecting EXT3-C-XR-T to EXT3-POE-XR-R

i In the example in [Figure 5](#), the connected USB devices, such as the mic or soundbar, are hosted via the transmitter's USB-C port (2). In this configuration, the receiver's host USB-B port (18) is inactive.

You can reverse the configuration and set the receiver's USB-B port as the active USB host, using the DIP-switches (see [Setting the DIP-Switches](#) on page 14).

To connect EXT3-C-XR-T to EXT3-POE-XR-R as illustrated in the example in [Figure 5](#):

1. Use the DIP-switches (16) and (33) to define one device as the active USB host (see [Setting the DIP-Switches](#) on page 14).

i Either the transmitter or the receiver (but not both) must be defined as the active USB host (see [Setting the DIP-Switches](#) on page 14).

2. Connect the HDBT OUT port (9) on the EXT3-C-XR-T transmitter side to the HDBT IN port (25) on the EXT3-POE-XR-R receiver side.
3. On the EXT3-C-XR-T transmitter side:
 - Connect a USB-C source (for example, a laptop that supports Display Port Alternate Mode) to the USB-C IN connector (2).
 - Connect an HDMI LOOP connector (10) to an HDMI acceptor.
5. On the EXT3-POE-XR-R receiver side, connect the HDMI OUT connector (26) to an HDMI acceptor (for example, a smart TV).

6. Connect the USB DEVICE ports:

- On the transmitter side, ports ⑪ and ⑫, to USB devices (for example, the room microphone, mouse, and keyboard).
- On the receiver side, ports ⑳ to ㉑, to USB devices (for example, a smart board, soundbar and camera).



USB devices can be connected to both the transmitter and receiver sides, as necessary.

7. To control the smart TV via IR, connect the following:

- On the **EXT3-C-XR-T** transmitter side, connect an IR sensor cable to the IR 3.5mm mini jack ⑬.
- On the **EXT3-POE-XR-R** receiver side, connect the IR 3.5mm mini jack ⑳ to an IR emitter cable and attach the cable emitter side to the IR sensor of the smart TV.

Point the smart TV IR remote controller to the IR sensor to pass an IR command via HDBT to the smart TV.

8. To Control the smart TV via Ethernet, connect the following:

- On the **EXT3-C-XR-T** transmitter side, connect a room controller (for example, the Kramer **SL-240C** with Kramer Control) via LAN to the Ethernet RJ-45 port ⑮.
- On the **EXT3-POE-XR-R** receiver side, connect the Ethernet RJ-45 port ㉒ to the smart TV.

Send IP commands via the room controller to the smart TV via LAN.

9. To control the PTZ camera, connect the following:

- On **EXT3-C-XR-T** transmitter side connect a controller (for example, **SL-240C** room controller) to the RS-232 port ⑭ (and to the ETHERNET RJ-45 port ⑮).
- On **EXT3-POE-XR-R** receiver side connect the RS-232 port ㉓ to a PTZ camera.

Send serial commands from **SL-240C** to the camera via RS-232.

10. Connect the power adapter to **EXT3-C-XR-T** and to the mains electricity (not shown in [Figure 5](#)).

To charge the device that is connected to the USB-C port, you need to use a power adapter for powering the **EXT3-C-XR-T** transmitter.

11. Connect the power adapter to **EXT3-POE-XR-R** and to the mains electricity (not shown in [Figure 5](#)).

EXT3-C-XR-T and **EXT3-POE-XR-R** are connected.

Connecting **EXT3-C-XR-T** or **EXT3-POE-XR-R** to Other **HDBaseT-compatible Devices**

You can connect **EXT3-C-XR-T** and **EXT3-POE-XR-R** to other HDBaseT-compatible devices that support HDBaseT 3.0 release or lower.

When **EXT3-C-XR-T** or **EXT3-POE-XR-R** are paired each to devices with a HDBaseT 3.0 release or lower, the features of the lower release device apply.

For example, you can connect:

- **EXT3-C-XR-T** to the Kramer **TP-590R** receiver.
- The Kramer **TP-590T** transmitter to **EXT3-POE-XR-R**.

For these paired sets:

- The maximum resolution that is supported is that of the highest common resolution. The **TP-590R** and **TP-590T** maximum resolution is 4K60 4:2:0 only, therefore the paired **TP-590R** and **TP-590T** define the maximum supported resolution.
- A shorter reach and USB extension are supported by each pair, therefore available per **TP-590R** and **TP-590T** capabilities.
- PoE powering and Ethernet are not supported by **TP-590R** and **TP-590T** so when paired with **EXT3-C-XR-T** and **EXT3-POE-XR-R**, respectively, are not available.

Connecting to EXT3-C-XR-T or EXT3-POE-XR-R via RS-232

You can connect via an RS-232 connection (14) or (31) using, for example, a PC.

EXT3-C-XR-T and EXT3-POE-XR-R feature an RS-232 3-pin terminal block connector to extend RS-232 signals via the EXT3-C-XR-T transmitter or EXT3-POE-XR-R receiver.

Connect the RS-232 terminal block on the rear panel to a device, as follows:

From the RS-232 9-pin D-sub serial port connect:

- Pin 2 to the TX pin on the RS-232 terminal block
- Pin 3 to the RX pin on the RS-232 terminal block
- Pin 5 to the G pin on the RS-232 terminal block

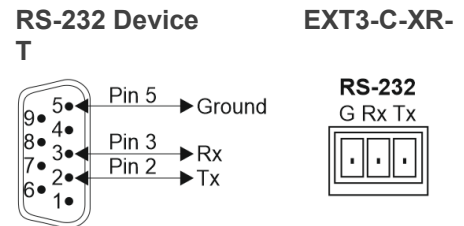

Wiring RJ-45 Connectors

This section defines the HDBT pinout, using a straight pin-to-pin cable with RJ-45 connectors.



It is recommended that the cable ground shielding be connected/soldered to the connector shield.



To achieve specified extension distances, use the recommended Kramer cables available at www.kramerav.com/product/EXT3-C-XR-T. Using third-party cables may cause damage!

EIA /TIA 568B	
PIN	Wire Color
1	Orange / White
2	Orange
3	Green / White
4	Blue
5	Blue / White
6	Green
7	Brown / White
8	Brown

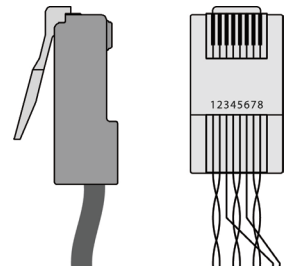

Setting the DIP-Switches

All changes in DIP-Switches apply immediately, on-the-fly (no need to power cycle the device), except for DIP-switches 2B and 3B which require the device to be power cycled. The DIP-switches are used to set the HDBT range, upgrade the firmware and determine IR signal pass-through.

 All the DIP-switches are set to **OFF** (up) by default.

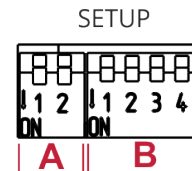

A – DIP-switch Settings

DIP #	Feature	DIP-1A	DIP-2A	State Description
1A, 2A	HDBT Range Mode	Off	Off	Standard range mode.
		On	Off	Ultra-long range mode.  Power cycle the device for the change to take effect.
		On	Off	TBD
		On	On	TBD

B – DIP-switch Settings

Changes to DIP-switches 2B and 3B only take effect after power cycling the device.

DIP #	Feature	DIP-switch Settings
1B	TBD	
2B	Active USB Host	Off (default) – The device is configured as the host for connected USB devices.
		On – USB are configured as slaves to the remote connection.
3B	IR Modulation	Off (default) – IR pass-thru is enabled.
		On – IR pass-thru is disabled (add a 38KHz modulation to the IR output signal).
4B	RS-232 operation Mode	Off (default) – RS-232 FW programming is inactive (Normal operation mode is enabled).
		On – RS-232 FW programming is active.

Display Power On/Off Control

EXT3-C-XR-T communicates with the remote HDMI display that is connected to the HDBaseT receiver, via the pass-through CEC channel.

Use the DISPLAY ON button  on the EXT3-C-XR-T to turn on or off the power of the display that is connected to the receiver. The DISPLAY ON button LED lights blue when display on the receiver side is powered on.

 EXT3-C-XR-T supports CEC functionality and has been tested and verified with a large number of display models. However, Kramer cannot guarantee CEC compatibility with all CEC displays due to command variations and proprietary commands implemented by some manufacturers in some of their displays.

Technical Specifications

EXT3-C-XR-T Specifications

Inputs	1 DP Alt Mode & PD 3.0 USB-C	On a USB-C female connector
Outputs	1 HDBT	On a female RJ-45 connector
	1 LOOP	On a female HDMI connector
Ports	2 USB 2.0	On USB type-A female connectors
	1 IR	On a 3.5mm mini jack for IR link extension
	1 RS-232	On a 3-pin terminal block for serial link extension
	1 Gbps LAN	On an RJ-45 female connector
Extension Line	Reach	Up to 100m (330ft), when using Kramer HDBaseT cables
	Standards Compliance	HDBaseT 3.0
Video	Max Data Rate	18Gbps bandwidth (6Gbps per graphic channel)
	Max Resolution	4K@60Hz (4:4:4) 24bpp resolution
	Content Protection	HDCP 2.3
	HDMI Support	4K as specified in HDMI 2.0b
Extended USB	Data Rate	Up to 480Mbps
	Transmitted Data Bandwidth	Up to 300Mbps
	Standards Compliance	1.1 and 2.0 USB
Extended Ethernet	Max Data Rate	1Gbps
Extended RS-232	Baud Rate	300 to 115200
Power	Power Adapter	Source: 20V DC, 6A Consumption: 20V DC, 4.35A Max. Power: 88W
	PoE	Consumption: 410mA Max. Power: 19.7W
	USB-C Charging	Max Power: 60W Compliance: PD 3.0
	USB Device Charging	Max. Total Current: 2A
Environmental Conditions	Operating Temperature	0° to +40°C (32° to 104°F)
	Storage Temperature	-40° to +70°C (-40° to 158°F)
	Humidity	10% to 90%, RHL non-condensing
Regulatory Compliance	Safety	CE
	Environmental	RoHs, WEEE
Enclosure	Size	Mega Tool
	Material	Aluminum
	Cooling	Convection Ventilation
General	Net Dimensions (W, D, H)	19cm x 11.3cm x 2.7cm (7.5" x 4.4" x 1.1")
	Shipping Dimensions (W, D, H)	34.5cm x 16.5cm x 5.2cm (13.6" x 6.5" x 2")
	Net Weight	0.56kg (1.2lbs)
	Shipping Weight	1.15kg (2.5lbs) approx.
Accessories	Included	Power adapter and cord, multi signal USB-C 1m cable
Specifications are subject to change without notice at www.kramerav.com		

EXT3-POE-XR-R Specifications

Input	1 HDBT PoE	On a female RJ-45 connector
Outputs	1 HDMI	On a female HDMI connector
Ports	3 USB 2.0	On USB type-A female connectors
	1 USB 2.0	On a USB type-B female connector
	1 IR	On a 3.5mm mini jack for IR link extension
	1 RS-232	On a 3-pin terminal block for serial link extension
	1 Gbps LAN	On an RJ-45 female connector
Extension Line	Reach	Up to Up to 100m (330ft) when using Kramer HDBaseT cables
	Standards Compliance	HDBaseT 3.0
Video	Max Data Rate	18Gbps bandwidth (6Gbps per graphic channel)
	Max Resolution	4K@60Hz (4:4:4) 24bpp resolution
	Content Protection	HDCP 2.3
	HDMI Support	4K as specified in HDMI 2.0b
Extended USB	Data Rate	Up to 480Mbps
	Transmitted Data Bandwidth	Up to 300Mbps
	Standards Compliance	1.1 and 2.0 USB
Extended Ethernet	Max Data Rate	1Gbps
Extended RS-232	Baud Rate	300 to 115200
Power	Power Adapter	Source: 48V DC, 1.36A Consumption: 48V DC, 1.2A Max. Power: 53W
	USB Device Charging	Max. Total Current: 2A
Environmental Conditions	Operating Temperature	0° to +40°C (32° to 104°F)
	Storage Temperature	-40° to +70°C (-40° to 158°F)
	Humidity	10% to 90%, RHL non-condensing
Regulatory Compliance	Safety	CE
	Environmental	RoHs, WEEE
Enclosure	Size	Mega Tools
	Material	Aluminum
	Cooling	Convection Ventilation
General	Net Dimensions (W, D, H)	19cm x 11.3cm x 2.7cm (7.5" x 4.4" x 1.1")
	Shipping Dimensions (W, D, H)	34.5cm x 16.5cm x 5.2cm (13.6" x 6.5" x 2")
	Net Weight	0.55kg (1.2lbs)
	Shipping Weight	1.12kg (2.5lbs) approx.
Accessories	Included	Power adapter and cord
Specifications are subject to change without notice at www.kramerav.com		

The warranty obligations of Kramer Electronics Inc. ("Kramer Electronics") for this product are limited to the terms set forth below:

What is Covered

This limited warranty covers defects in materials and workmanship in this product.

What is Not Covered

This limited warranty does not cover any damage, deterioration or malfunction resulting from any alteration, modification, improper or unreasonable use or maintenance, misuse, abuse, accident, neglect, exposure to excess moisture, fire, improper packing and shipping (such claims must be presented to the carrier), lightning, power surges, or other acts of nature. This limited warranty does not cover any damage, deterioration or malfunction resulting from the installation or removal of this product from any installation, any unauthorized tampering with this product, any repairs attempted by anyone unauthorized by Kramer Electronics to make such repairs, or any other cause which does not relate directly to a defect in materials and/or workmanship of this product. This limited warranty does not cover cartons, equipment enclosures, cables or accessories used in conjunction with this product.

Without limiting any other exclusion herein, Kramer Electronics does not warrant that the product covered hereby, including, without limitation, the technology and/or integrated circuit(s) included in the product, will not become obsolete or that such items are or will remain compatible with any other product or technology with which the product may be used.

How Long this Coverage Lasts

The standard limited warranty for Kramer products is seven (7) years from the date of original purchase, with the following exceptions:

1. All Kramer VIA hardware products are covered by a standard three (3) year warranty for the VIA hardware and a standard three (3) year warranty for firmware and software updates; all Kramer VIA accessories, adapters, tags, and dongles are covered by a standard one (1) year warranty.
2. Kramer fiber optic cables, adapter-size fiber optic extenders, pluggable optical modules, active cables, cable retractors, ring mounted adapters, portable power chargers, Kramer speakers, and Kramer touch panels are covered by a standard one (1) year warranty. Kramer 7-inch touch panels purchased on or after April 1st, 2020 are covered by a standard two (2) year warranty.
3. All Kramer Calibre products, all Kramer Minicom digital signage products, all HighSecLabs products, all streaming, and all wireless products are covered by a standard three (3) year warranty.
4. All Sierra Video MultiViewers are covered by a standard five (5) year warranty.
5. Sierra switchers & control panels are covered by a standard seven (7) year warranty (excluding power supplies and fans that are covered for three (3) years).
6. K-Touch software is covered by a standard one (1) year warranty for software updates.
7. All Kramer passive cables are covered by a lifetime warranty.

Who is Covered

Only the original purchaser of this product is covered under this limited warranty. This limited warranty is not transferable to subsequent purchasers or owners of this product.

What Kramer Electronics Will Do

Kramer Electronics will, at its sole option, provide one of the following three remedies to whatever extent it shall deem necessary to satisfy a proper claim under this limited warranty:

1. Elect to repair or facilitate the repair of any defective parts within a reasonable period of time, free of any charge for the necessary parts and labor to complete the repair and restore this product to its proper operating condition. Kramer Electronics will also pay the shipping costs necessary to return this product once the repair is complete.
2. Replace this product with a direct replacement or with a similar product deemed by Kramer Electronics to perform substantially the same function as the original product. If a direct or similar replacement product is supplied, the original product's end warranty date remains unchanged and is transferred to the replacement product.
3. Issue a refund of the original purchase price less depreciation to be determined based on the age of the product at the time remedy is sought under this limited warranty.

What Kramer Electronics Will Not Do Under This Limited Warranty

If this product is returned to Kramer Electronics or the authorized dealer from which it was purchased or any other party authorized to repair Kramer Electronics products, this product must be insured during shipment, with the insurance and shipping charges prepaid by you. If this product is returned uninsured, you assume all risks of loss or damage during shipment. Kramer Electronics will not be responsible for any costs related to the removal or re-installation of this product from or into any installation. Kramer Electronics will not be responsible for any costs related to any setting up this product, any adjustment of user controls or any programming required for a specific installation of this product.

How to Obtain a Remedy Under This Limited Warranty

To obtain a remedy under this limited warranty, you must contact either the authorized Kramer Electronics reseller from whom you purchased this product or the Kramer Electronics office nearest you. For a list of authorized Kramer Electronics resellers and/or Kramer Electronics authorized service providers, visit our web site at www.kramerav.com or contact the Kramer Electronics office nearest you.

In order to pursue any remedy under this limited warranty, you must possess an original, dated receipt as proof of purchase from an authorized Kramer Electronics reseller. If this product is returned under this limited warranty, a return authorization number, obtained from Kramer Electronics, will be required (RMA number).

You may also be directed to an authorized reseller or a person authorized by Kramer Electronics to repair the product.

If it is decided that this product should be returned directly to Kramer Electronics, this product should be properly packed, preferably in the original carton, for shipping. Cartons not bearing a return authorization number will be refused.

Limitation of Liability

THE MAXIMUM LIABILITY OF KRAMER ELECTRONICS UNDER THIS LIMITED WARRANTY SHALL NOT EXCEED THE ACTUAL PURCHASE PRICE PAID FOR THE PRODUCT. TO THE MAXIMUM EXTENT PERMITTED BY LAW, KRAMER ELECTRONICS IS NOT RESPONSIBLE FOR DIRECT, SPECIAL, INCIDENTAL OR CONSEQUENTIAL DAMAGES RESULTING FROM ANY BREACH OF WARRANTY OR CONDITION, OR UNDER ANY OTHER LEGAL THEORY. Some countries, districts or states do not allow the exclusion or limitation of relief, special, incidental, consequential or indirect damages, or the limitation of liability to specified amounts, so the above limitations or exclusions may not apply to you.

Exclusive Remedy

TO THE MAXIMUM EXTENT PERMITTED BY LAW, THIS LIMITED WARRANTY AND THE REMEDIES SET FORTH ABOVE ARE EXCLUSIVE AND IN LIEU OF ALL OTHER WARRANTIES, REMEDIES AND CONDITIONS, WHETHER ORAL OR WRITTEN, EXPRESS OR IMPLIED. TO THE MAXIMUM EXTENT PERMITTED BY LAW, KRAMER ELECTRONICS SPECIFICALLY DISCLAIMS ANY AND ALL IMPLIED WARRANTIES, INCLUDING, WITHOUT LIMITATION, WARRANTIES OF MERCHANTABILITY AND FITNESS FOR A PARTICULAR PURPOSE. IF KRAMER ELECTRONICS CANNOT LAWFULLY DISCLAIM OR EXCLUDE IMPLIED WARRANTIES UNDER APPLICABLE LAW, THEN ALL IMPLIED WARRANTIES COVERING THIS PRODUCT, INCLUDING WARRANTIES OF MERCHANTABILITY AND FITNESS FOR A PARTICULAR PURPOSE, SHALL APPLY TO THIS PRODUCT AS PROVIDED UNDER APPLICABLE LAW. IF ANY PRODUCT TO WHICH THIS LIMITED WARRANTY APPLIES IS A "CONSUMER PRODUCT" UNDER THE MAGNUSON-MOSS WARRANTY ACT (15 U.S.C.A. §2301, ET SEQ.) OR OTHER APPLICABLE LAW, THE FOREGOING DISCLAIMER OF IMPLIED WARRANTIES SHALL NOT APPLY TO YOU, AND ALL IMPLIED WARRANTIES ON THIS PRODUCT, INCLUDING WARRANTIES OF MERCHANTABILITY AND FITNESS FOR THE PARTICULAR PURPOSE, SHALL APPLY AS PROVIDED UNDER APPLICABLE LAW.

Other Conditions

This limited warranty gives you specific legal rights, and you may have other rights which vary from country to country or state to state.

This limited warranty is void if (i) the label bearing the serial number of this product has been removed or defaced, (ii) the product is not distributed by Kramer Electronics or (iii) this product is not purchased from an authorized Kramer Electronics reseller. If you are unsure whether a reseller is an authorized Kramer Electronics reseller, visit our web site at www.kramerav.com or contact a Kramer Electronics office from the list at the end of this document.

Your rights under this limited warranty are not diminished if you do not complete and return the product registration form or complete and submit the online product registration form. Kramer Electronics thanks you for purchasing a Kramer Electronics product. We hope it will give you years of satisfaction.



HDMI™
HIGH-DEFINITION MULTIMEDIA INTERFACE



P/N:



2900-301567

Rev:



2



SAFETY WARNING

Disconnect the unit from the power supply before opening and servicing

For the latest information on our products and a list of Kramer distributors, visit our website where updates to this user manual may be found.

We welcome your questions, comments, and feedback.

The terms HDMI, HDMI High-Definition Multimedia Interface, and the HDMI Logo are trademarks or registered trademarks of HDMI Licensing Administrator, Inc. All brand names, product names, and trademarks are the property of their respective owners.